

PRODUCT DATA SHEET

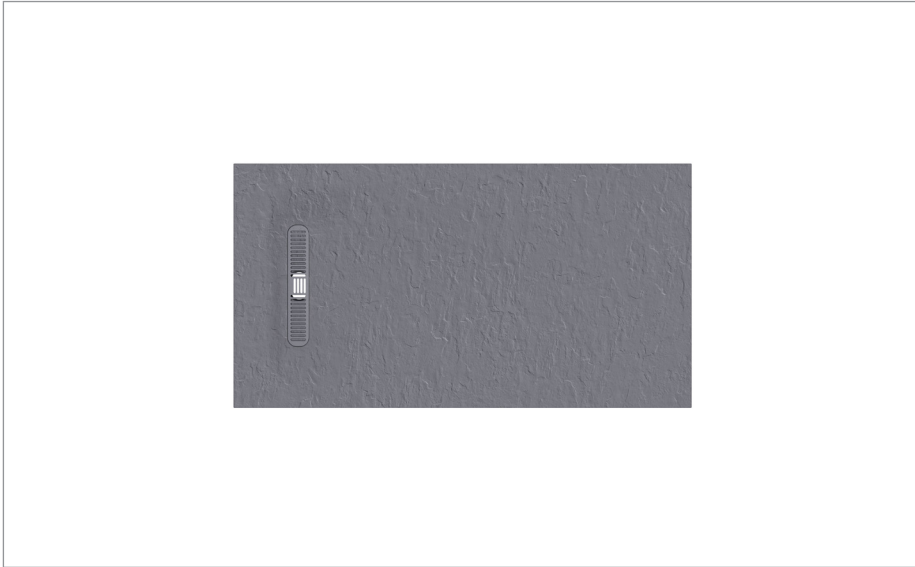

PRODUCT CODE

VTR800X1500TEXG

RANGE

25mm Vito

DESCRIPTION

Vito Textured Rectangle Anti Slip Class C Shower Tray 800 x 1500 Light Grey

WEBSITE LINK

[Click Here](#)

CATEGORY	Showering
WARRANTY DETAILS	Lifetime
COLOUR	Light Grey
FINISH APPLICATION	Gelcoat/Nanocoat
PRIMARY MATERIAL	Dolomite
SECONDARY MATERIAL	Stone Resin
INSTALL TYPE	Floor Mounted
PRODUCT WIDTH MM	800
PRODUCT HEIGHT MM	36
PRODUCT LENGTH MM	1500
PRODUCT NET WEIGHT KG	59.93

STANDARDS	EN 14527
WASTE INCLUDED	No
OUTER EDGE DIMENSION - TRAYS (MM)	60
WASTE LOCATION	End drain
ANTI-SLIP CLASS	C
DRYING AREA	NO
RISER KIT COMPATIBLE	Yes
RISER KIT INCLUDED	No
TRAY PLANE TOLERANCE (MM)	+/- 3mm
TRAY WIDTH TOLERANCE MM	+5/-0
TRAY LENGTH TOLERANCE MM	+5/-0
TRAY HEIGHT TOLERANCE MM	+2/-2
TRAY WASTE HOLE TOLERANCE MM	+2/-2
COLOUR CODE / REFERENCE	71

TECHNICAL DIMENSIONS

Dimensions in mm unless otherwise specified.

Tolerances (per material type) apply.

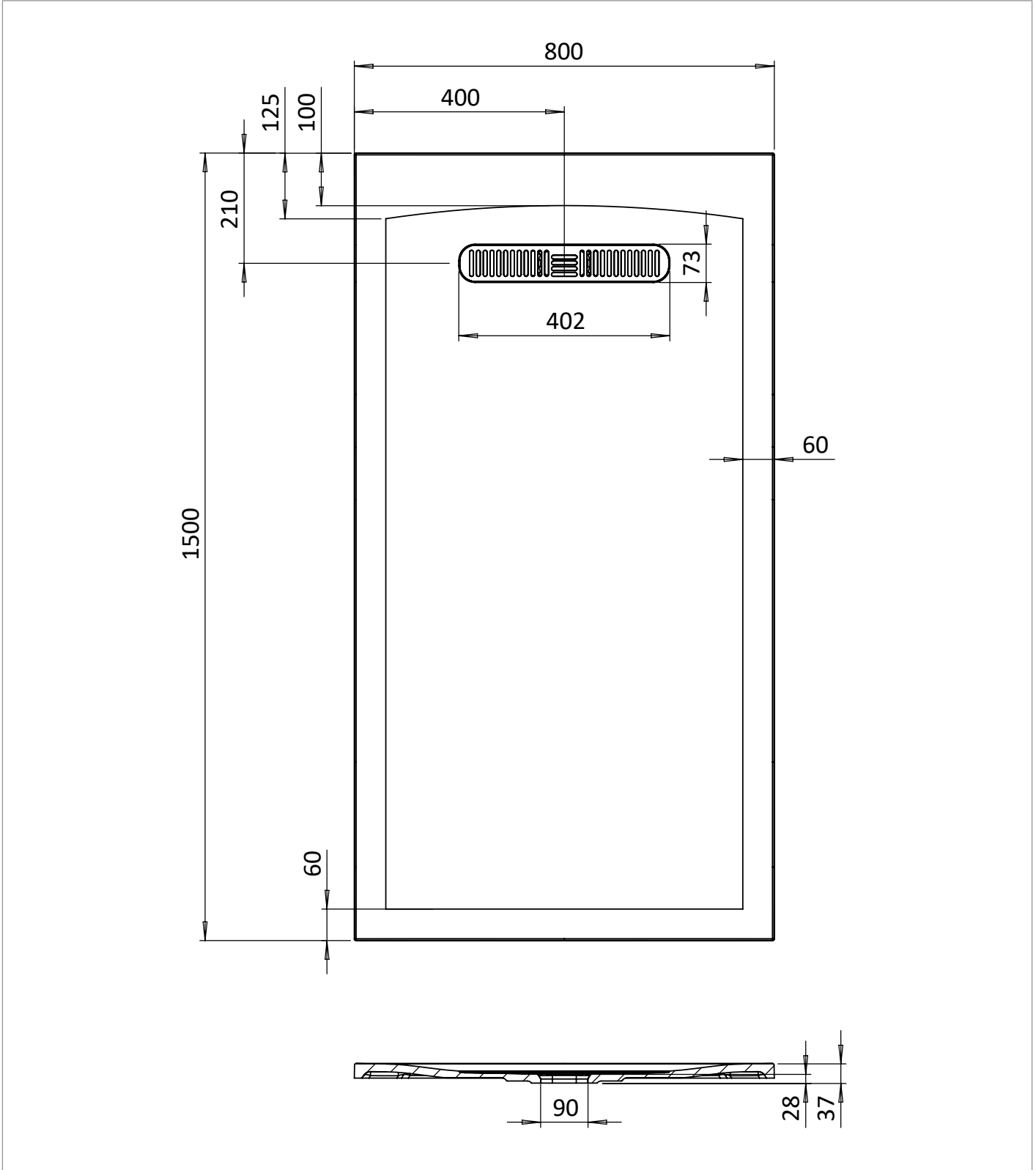

SPARES LIST

Only the parts labelled are available as spares.

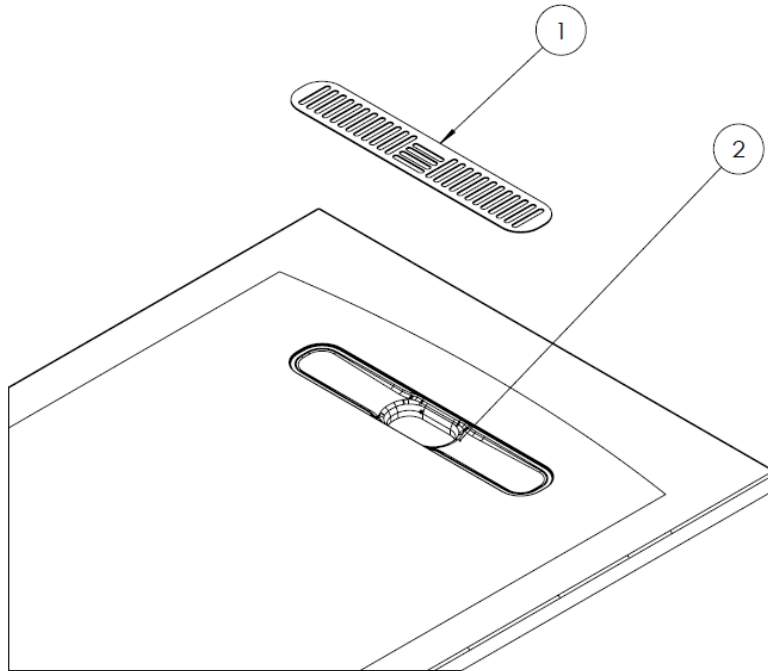

NUMBER	PART CODE	DESCRIPTION
1	VITOWASTEW	Vito Shower Waste Cover White
	VITOWASTEMW	Vito Shower Waste Cover Matt White
	VITOWASTEBR	Vito Textured Shower Waste Flange Brown
	VITOWASTELG	Vito Shower Waste Cover Grey
	VITOWASTEMB	Vito Shower Waste Cover Matt Black
	VITOWASTEG	Vito Shower Waste Cover Grey
2	VITOFLANGE	Vito Shower Waste Flange White
	VITOFLANGEBR	Vito Textured Shower Waste Cover Brown
	VITOFLANGELG	Vito Textured Shower Waste Cover Light Grey
	VITOFLANGEMB	Vito Shower Waste Flange Matt Black
	VITOFLANGEG	Vito Shower Waste Flange Grey
	MINERALPOLISH	Cast Mineral Marble Polishing Compound
	MINERALREPAIRKITWG	Cast Mineral Marble Repair Kit White Gloss
	MINERALTOUCHKITWG	Cast Mineral Marble Touch Up Kit White Gloss

PRODUCT DATA SHEET



PRODUCT CODE

VTHFWS90

RANGE

25mm Vito

DESCRIPTION

Vito Shower Tray Waste 90mm

WEBSITE LINK

[Click Here](#)

CATEGORY	Showering
WARRANTY DETAILS	2 Years
COLOUR	Grey
PRIMARY MATERIAL	NEOPRENE
PRODUCT WIDTH MM	90
PRODUCT HEIGHT MM	115
PRODUCT LENGTH MM	90
PRODUCT NET WEIGHT KG	0.2

STANDARDS	EN274
-----------	-------

TECHNICAL DIMENSIONS

Dimensions in mm unless otherwise specified.

Tolerances (per material type) apply.

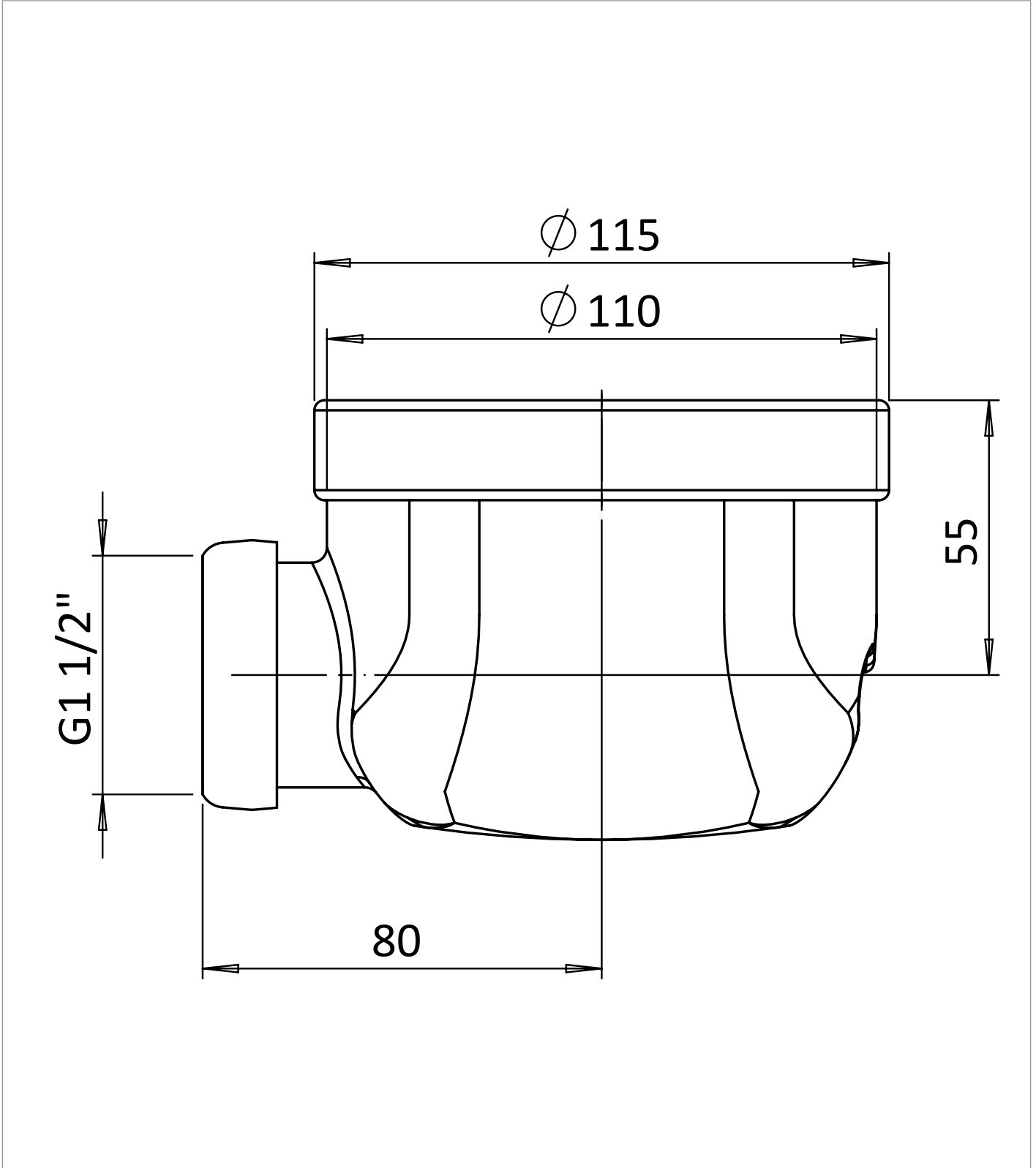

SPARES LIST

Only the parts labelled are available as spares.

NO SPARES AVAILABLE