

# Technical Data Sheet

# TAVISTOCK

## ARLO 500mm Wall Mounted Unit

Whats in the box: 1x AR5W1-XXX

\*Reference basin TDS for further info

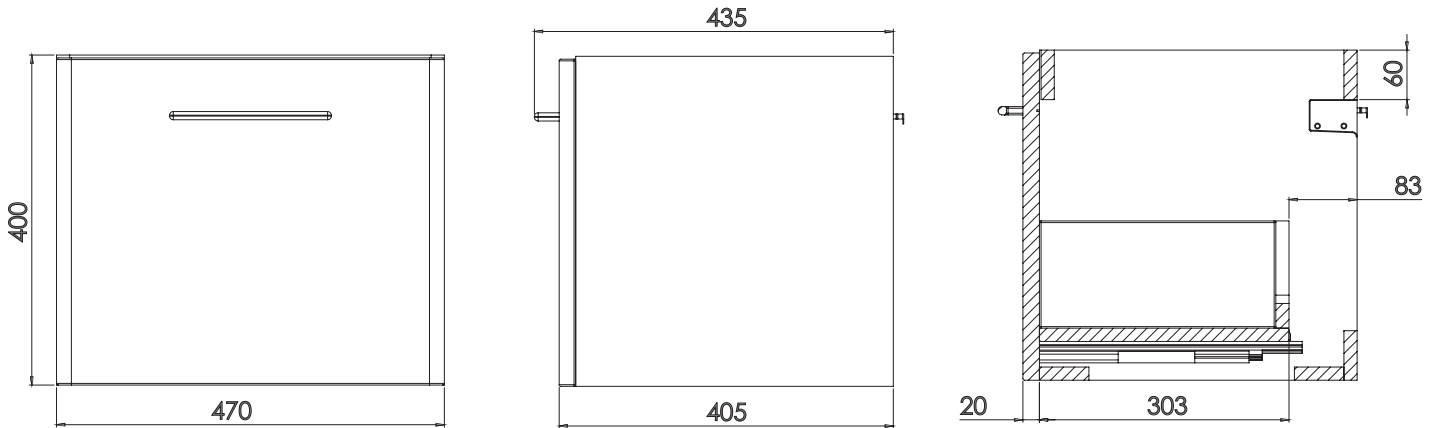

Diagrams not to scale  
All dimensions in mm  
tolerance of +/-5mm

### Materials

Carcass: 16mm painted & melamine faced MFC  
Fascia Components: 20mm painted MDF

\*\*Dimensions are subject to change, customers are advised to measure actual product before commencing installation.

\*\*\*Fixing point dimensions are for guidance only/the positions of wall fixing must be checked when product is received.

### FAQs

- |  |  |
|--|--|
| Q: Are the handles fitted?                                 | A: No, handles require fitting. Unit comes with pilot holes drilled on back face. Chrome 160mm centre handle included with fixings |
| Q: Are the drawer runners adjustable?                      | A: Yes, tilt adjustment can be made. Refer to instructions.  |
| Q: Are the drawer runners soft close?                      | A: Yes.  |
| Q: How thick is the drawer fascia?                         | A: 20mm with a 18mm radius in corners.   |
| Q: How deep/wide is the unit with doors open?              | A: Approx depth with 90 degree hinge 650mm.  |
| Q: What is the drawer depth?                               | A: Approx. 280mm depth   |
| Q: What is the internal finish of the unit?                | A: Dark grey internal finish on all finishes.  |
| Q: Is the base of unit suppose to have no full depth base? | A: Yes, 60mm braces replace a full depth base to reduce weight as identified as unnecessary excess material.                       |

NOTE: Colours unique to Tavistock - No RAL Code available

# Technical Data Sheet

# TAVISTOCK

## ARLO 500 Ceramic Basin

Whats in the box: 1x AR500C

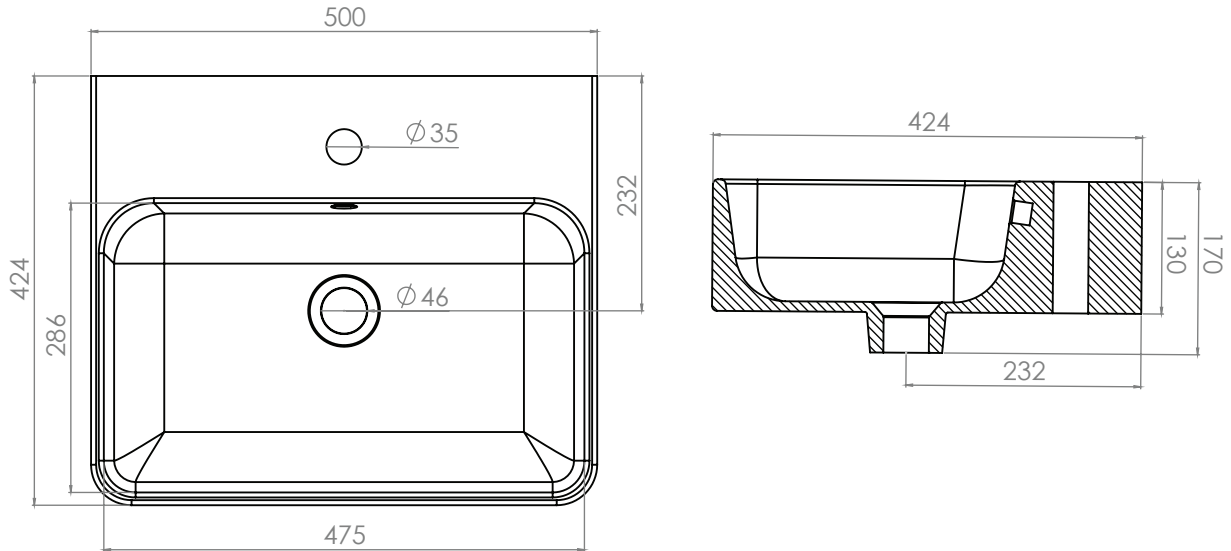

Diagrams not to scale  
All dimensions in mm  
tolerance of +/-5mm

### Materials

Basin: Ceramic

\*\*Dimensions are subject to change, customers are advised to measure actual product before commencing installation.

### FAQs

- |   |                                 |
|---|---------------------------------|
| Q: What is the maximum water depth of the basin?                | A: 63mm up to the overflow.     |
| Q: What is the internal depth?                                  | A: The internal depth is 118mm. |
| Q: What is the depth of the tapledge?                           | A: The tapledge is 130mm deep.  |
| Q: What is the distance from the taphole centre to basin waste? | A: 125mm                        |
| Q: What is the overflow rating?                                 | A: Overflow rating is CL15      |

NOTE: Colours unique to Tavistock - No RAL Code available