

crosswater[®]

Laminate Installation Guide

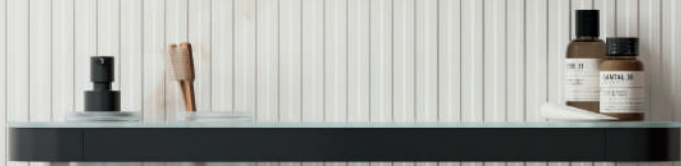

Contents

It is essential to read this guide thoroughly before commencing installation.

Installer Responsibility	02
Important do's and don'ts and a pre installation checklist	
Section One	04
Preparation	
Section Two	06
Installation steps for two sided shower enclosures	
Section Three	08
Installation steps for three sided shower enclosures and sealing instruction	
Section Four	09
Preparation advice and installation steps for ProClick panels	
Care, Maintenance & Guarantee	16
Advice for the cleaning and maintaining the installed wall panels. Plus a summary of the guarantee.	

Installer Responsibility

INSTALLATION DETAILS

IMPORTANT DETAILS

Before starting installation, read this guide thoroughly to ensure optimal product performance. To keep your guarantee valid, all instructions must be followed. Any deviation will void the guarantee.

Installers must confirm product colour and décor suitability with the end user before beginning.

If these instructions don't cover a specific aspect of your installation, please contact the helpline for guidance before proceeding.

PLEASE DO

- Do** always store panels flat to prevent bowing.
- Do** acclimatise the product prior to installation in normal heated conditions, 24 hours.
- Do** use the Showerwall sealant and adhesive.
- Do** ensure the Showerwall sealant is applied correctly at all stated points.
- Do** closely inspect each panel for surface defects prior to and during installation.
- Do** handle the panels carefully to avoid damage to the profiled edges.

PLEASE DON'T

- Don't** store the panels outside or in wet / humid conditions.
- Don't** store the panels propped against a wall on edge or end.
- Don't** use abrasive cleaners and bleaches to clean the panels.
- Don't** fit Crosswater panels without correctly sealing every joint.
- Don't** proceed with installation if you notice any defects or have concerns.

BEFORE YOU START

CHECK CONTENTS

Check all components before installation.

If anything is missing, contact your supplier immediately. Crosswater is not liable for labour or downtime costs in such cases.

CHECK APPEARANCE

Inspect panels before installation.

Panels come boxed - check for visual defects and edge damage before fitting, as post-installation claims won't be covered by the guarantee. Once the panels have been installed they are deemed to be acceptable in relation to any visual defects.

Remove the protective film to inspect the surface properly.

Slight colour variations and unmatched décor patterns are normal due to the printing process and are not grounds for complaint.

Installation Components

COMPONENTS AND FITTINGS

AVAILABLE COMPONENTS

Ensure that you have all components required for your particular installation. This includes your panels of choice and all applicable accessories;

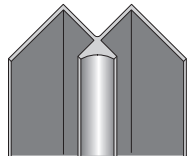

Internal Corner

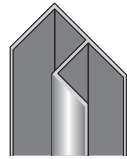

External Corner

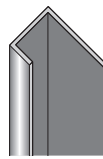

End Trim

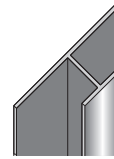

Joining Trim

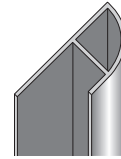

Quadrant Trim

RECOMMENDED TOOLS

In addition to our profiles and adhesives we recommend the following tools for installation;

Tape Measure

Jigsaw*

Suction Grips

1200mm Spirit Level

Cleaning Wipes

Protective Gloves

Handsaw*

Drill

Protective Goggles

Utility Knife

Sealant Gun

Ear Protection

Hacksaw

Masking Tape

Mitre Block

Circular Saw*

ADHESIVE, SEALANTS & CLEANERS

Recommended Products and Maintenance Guidelines

For optimal fitting, sealing, and maintenance, we strongly recommend using Showerwall's own brand products. Use of alternative products will void your guarantee.

Recommended Products:

SHOWERWALL ADHESIVE

High-grab, high-bond MS Polymer-based adhesive for superior panel fixing.

SHOWERWALL SEALANT

Fast-curing, low-modulus sealant for panels and sanitaryware, easy to apply and smooth.

Refer to the table below for recommended adhesive and sealant usage volumes.



IMPORTANT MAINTENANCE NOTE: If the Sureseal strip is not used, exposed bottom edge sealants may degrade over time and should be replaced periodically based on shower usage. Failure to maintain these areas can lead to water ingress and panel damage, which is not covered by the guarantee.

* Fine toothed blade.

Please ensure all tools are used safely and correctly and appropriate safety wear such as gloves, eye and ear protection are used.

Preparation

SECTION ONE

MEASURE & MARKING

Measure and mark your required cutting line. If your panels are to be installed full height to ceiling level, cut the height of the panel to allow a 3mm expansion gap at the ceiling point which will be filled with sealant on completion.

NOTE: Always consider and allow for the specified trim dimensions when cutting the panelling to size.

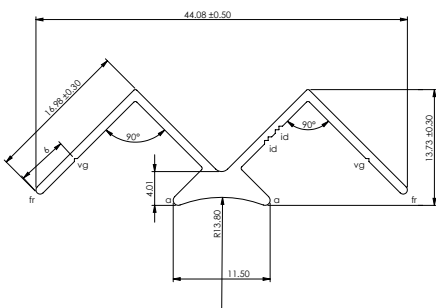

Internal Corner

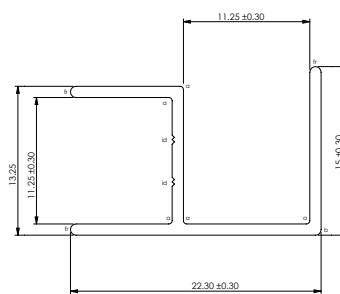

External Corner

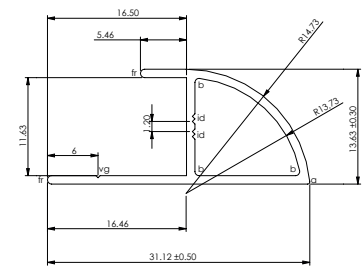

Quadrant Trim

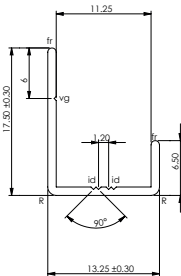

End Trim

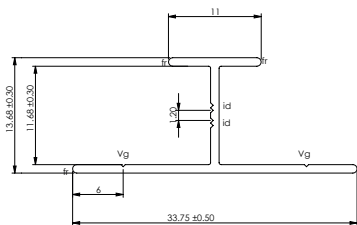

Joining Trim

Preparation

CUTTING

When using a fine-tooth blade handsaw, panels should be cut decorative face up. When using a jigsaw or circular saw with an upward cutting blade, the panels should be cut from the back, decorative face down to prevent chipping of the laminate surface.

NOTE: Always consider and allow for the specified trim dimensions when cutting the panelling to size.

WALL PREPARATION

- Fixing Square Edge Panels (Excluding ProClick)
- When installing panels directly onto tiles, plasterboard, or plastered walls (not using battens), ensure:
 - Walls are sound, plumb, dry, dust-free, and clean
 - Dampness is treated before installation
 - Tiled surfaces must be secure and degreased
 - New or dusty plaster should be sealed with PVA
 - Uneven or damaged surfaces must be repaired to meet installation standards
- Remove high spots or protruding tiles that could cause warping
- Loose tiles must be removed
- Shower tray must be installed level (check with spirit level)
- If walls are uneven +/- 3mm or out of plumb, install timber battens as a frame. Ensure battens are fixed, plumb, and square
- For ProClick panels, see Section 5 on batten installation

Square Edge Panels

SECTION TWO

TWO SIDED INSTALLATION

Please note: Internal corner trims are optional for Hydrocore panels only. Where internal corner trims are not used (Hydrocore only) joints must still be fully sealed using Showerwall silicone sealer.

ONE

Apply continuous adhesive beads along the back of the internal corner trim. Fix it in place, ensuring it's plumb with a spirit level.

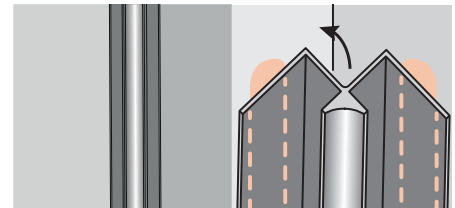

TWO

Apply Showerwall sealant into the left hand channel recess of the internal corner trim in sufficient quantities to ensure the sealant fully envelopes the edges of the panel when inserted.

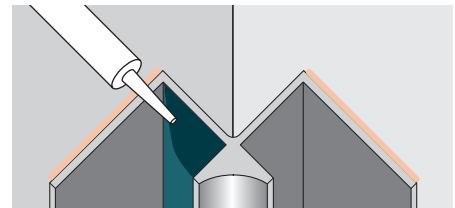

THREE

Before installing the cut panel, clean all edges with suitable wipes. Apply a generous bead of sealant into the end trim recess and fit it onto the panel's left edge, ensuring the sealant fully envelopes the panel edge.

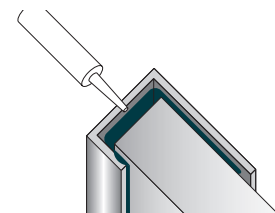

FOUR

Apply 6mm wavy vertical adhesive beads, spaced 150mm apart. Add more as needed until the full recommended amount is used.

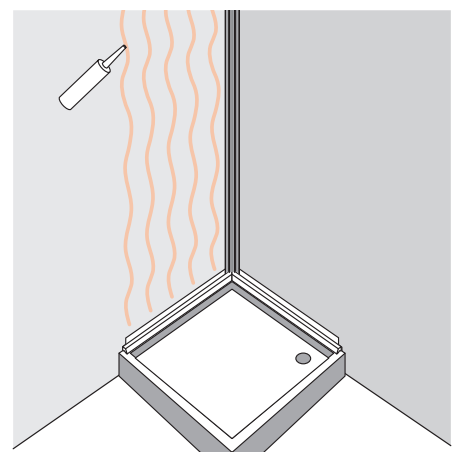

Square Edge Panels

FIVE

Position the panel on 3mm spacers, sliding the edge into the internal corner trim. Ensure it's firmly seated and fully enveloped in sealant. Excess sealant should squeeze out at the base, sealing the bottom edge base trim and the front face of the panel, fully enveloping the bottom edge.

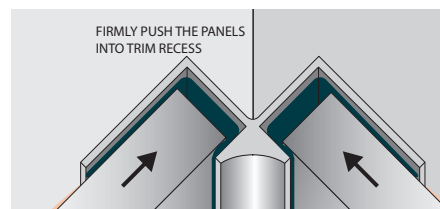

SIX

Press evenly across the panel to ensure full adhesive contact. Repeat previous steps for each additional panel.

SEVEN

Use a Sealant Profiler to smooth the sealant line, ensuring a flush, consistent finish. Reapply and reprofile if needed.

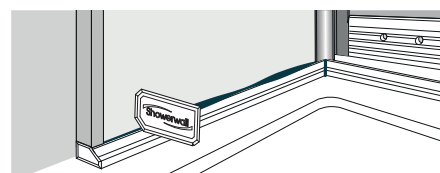

EIGHT

Seal the 3mm gap between the panel top and ceiling with Showerwall sealant, ensuring full coverage. Allow adhesive and sealant to cure for 24 hours. After fitting your shower cubicle, clean the panels using non-abrasive cleaner.

Square Edge Panels

SECTION THREE

THREE SIDED SHOWER STEPS

Please note: Internal corner trims are optional for Hydrocore panels only. Where internal corner trims are not used (Hydrocore only) joints must still be fully sealed using Showerwall silicone sealer.

ONE

Install left hand internal corner trim as detailed in step 1 of Section 3.

TWO

Install the left hand wall panel as detailed in step 2-6 of Section 3.

THREE

Measure and cut the centre panel to size, allowing for the additional right hand internal corner trim to be used.

FOUR

Apply sealant into the right hand recess of the installed internal corner trim.

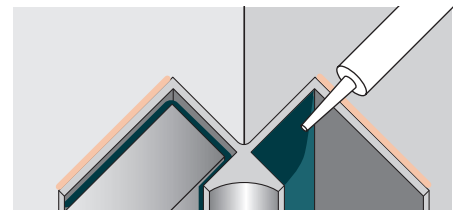

FIVE

Apply Showerwall sealant into the left-hand recess of the second internal corner trim. Firmly fit the trim onto the right-hand edge of the center panel, ensuring the panel edge is fully enveloped in sealant.

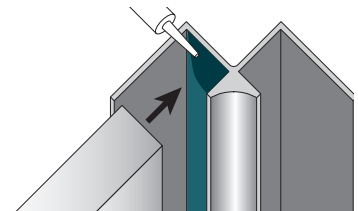

SIX

Repeat steps 4–5 of Section 3 for the adhesive wall and sealant application method. Then apply Showerwall adhesive to the back edges of the right-hand internal corner trim.

Attach suction grips to the face of the panel to make handling this panel easier.

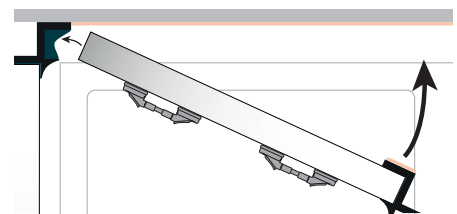

SEVEN

Position the bottom edge of the panel onto spacers. Slot the left-hand panel edge into the right-hand recess of the fitted internal corner, then rotate and press the panel firmly into the adhesive.

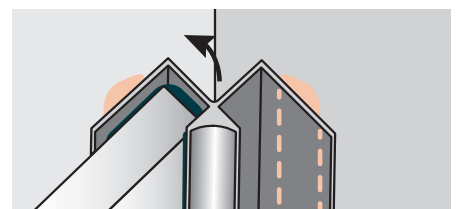

EIGHT

Repeat steps 2-11 from Section 3 for fitting of the final right-hand panel.

Square Edge Panels

SEALING PIPES, HOLES & CUT OUTS

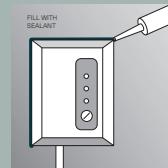
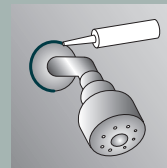
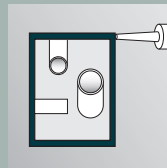
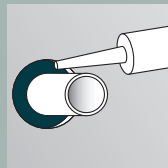
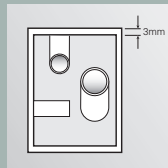
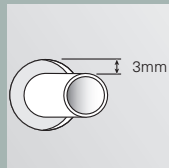

When cutting out or drilling holes into your panels to accommodate pipes or shower units, ensure a clearance space of 3mm width is left between the fixed object being cut around and the panel edge.

The 3mm clearance space must then be fully filled with Showerwall sealant once the panels are installed and before any fittings or shower units are fitted.

Following the fitting of any shower units or pipe collars etc. always seal the shower unit casing or pipe collars again to ensure a further watertight seal exists externally around the unit / collars.

Note: Failure to adequately seal any cut edge sections of the panel may result in the panel edges swelling and will invalidate your product guarantee.

ProClick Panels

SECTION FOUR

PLANNING CONSIDERATIONS

ProClick panels can be used to cover entire rooms or multiple walls.

Start installation from a corner, working outwards in both directions, and finish by cutting and fitting the final square panel above the doorway.

Where possible, center the panel layout to avoid narrow strips at corners. Avoid placing panel joints where they may be exposed to continuous water flow, such as under shower heads.

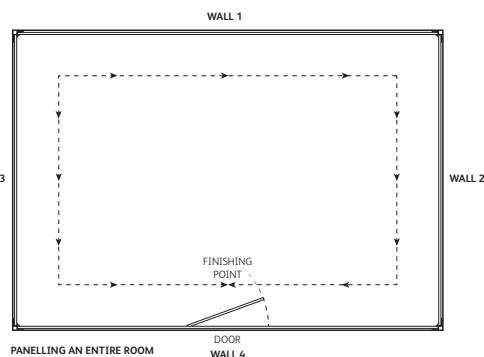
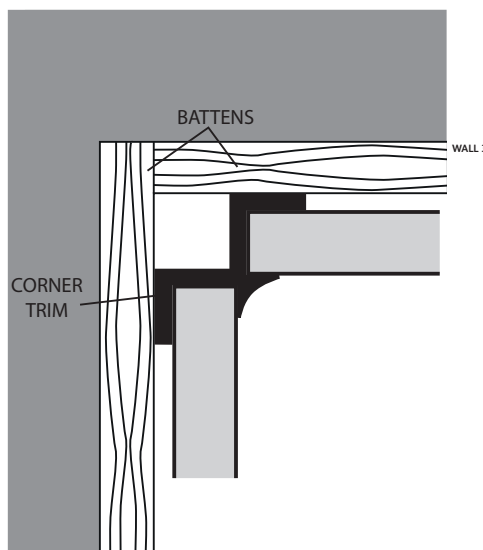

ProClick Panels

FIXING TIMBER BATTENS

If walls are not plumb or flat, ProClick panels must be fixed to a timber batten frame using Showerwall adhesive or screws at 600mm centres.

Use uniform 25mm x 50mm timber battens, fixed vertically at 585mm centres for 585mm panels. Ensure all vertical joints are supported by battens, spaced to match the panel width.

All battens must be plumb, parallel, and level, using spacers as needed. Include additional battens to support heavy items (e.g. basins, wall-hung toilets, furniture), and in corners to support corner profiles.

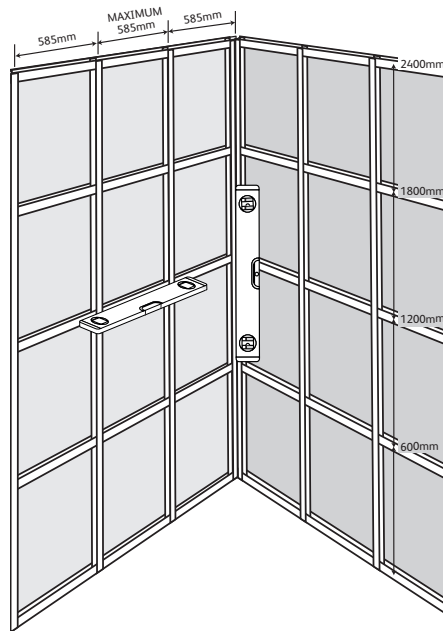

RECOMMENDED FIXINGS



Flat Head Countersunk Screw
18mm (¾") x No. 6

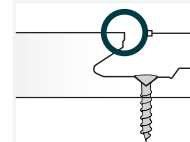

Take care to avoid the face edge being damaged while drilling pilot holes and inserting screws

NOTE: If your bottom support is not level it will affect the vertical panel joints and top panel edge of the installed panels. Pattern matches are not guaranteed.

PANEL BASE & FLOOR DETAIL

Use 3mm spacers to leave a 3mm gap at the bottom panel edge which will be filled with sealant.

INSTALLATION STEPS

Please note: Internal corner trims are optional for Hydrocore panels only. Where internal corner trims are not used (Hydrocore only) joints must still be fully sealed using Showerwall silicone sealer.

ONE

Apply continuous beads of Showerwall panel adhesive along the entire length of the back of the internal corner trim. Position the trim and use a spirit level to ensure it is plumb.

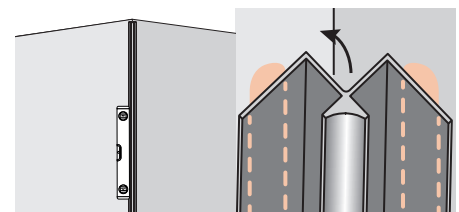

TWO

Remove the ProClick tongue from the first panel to leave a clean, square edge.

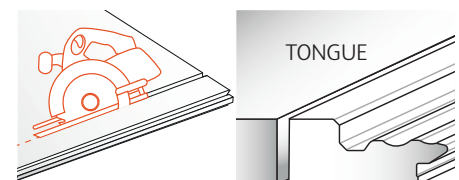

ProClick Panels

THREE

Apply sealant into the left hand channel recess of the internal corner trim in sufficient quantities to ensure the sealant fully envelopes the edges of the panel when inserted.

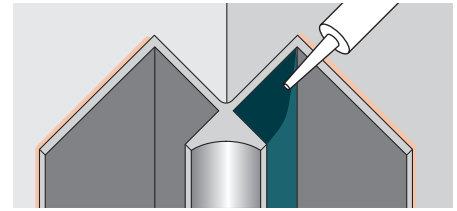

FOUR

Apply 6mm wavy vertical adhesive beads, spaced 150mm apart. Add more as needed until the full recommended amount is used.

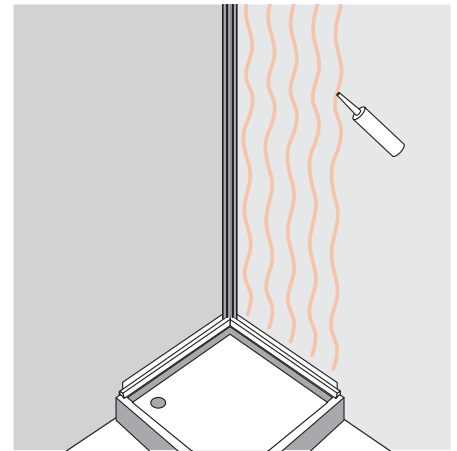

FIVE

Attach suction grips to the front of the first panel for easier handling. Lift and position the bottom edge onto 3mm spacers, then slide the square-cut edge into the installed corner trim. Ensure the panel is fully inserted and the sealant completely surrounds the edge.

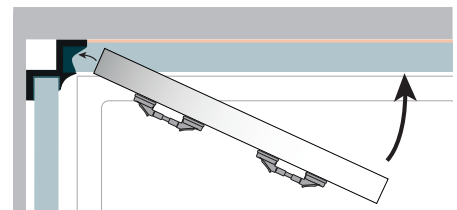

Note: Apply even pressure across the panel face to ensure sound contact of the adhesive to the reverse of the panels. Repeat for each panel.

SIX

Repeat the adhesive application for the next wall section (Step 4). Using an uncut nozzle, apply a small, continuous bead of sealant along the full length of the ProClick tongue shoulder.

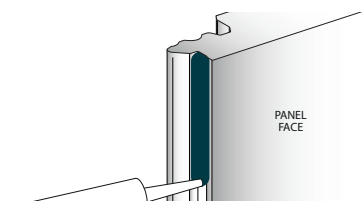

ProClick Panels

SEVEN

Angle the panel to locate its bottom edge onto the 3mm spacers. Slot the tongue into the groove of the previous panel, ensuring full engagement, flush top edges, and an even squeeze-out of sealant to lock the joint. Rotate the panel flat against the wall.

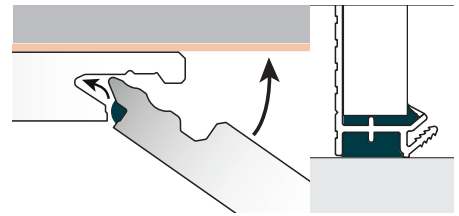

EIGHT

Immediately clean any sealant overspill from the joint and panel surface after assembly.

NINE

Repeat steps 6–7 for each panel, checking that all edges are plumb and level with a spirit level after installation.



TEN

Measure and cut the final panel to width, removing the groove side if needed. Ensure the width accounts for the internal corner trim, as outlined in Section 1.

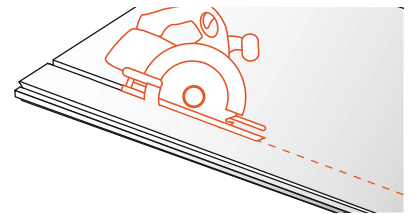

ELEVEN

Generously apply sealant into the left recess of the internal corner trim, ensuring it fully covers the panel edge. Firmly fit the trim onto the square-cut edge.

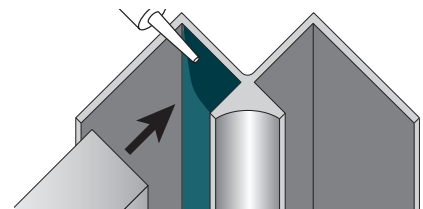

TWELVE

Repeat steps 4, 6, and 7. Fit the ProClick edge into the groove of the previous panel, then firmly press the panel and corner trim onto the adhesive.

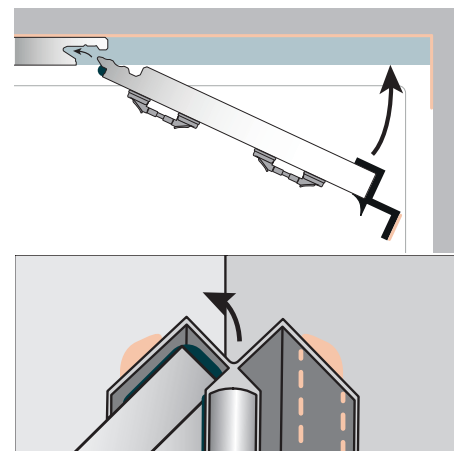

ProClick Panels

THIRTEEN

Apply continuous beads of panel adhesive along the entire length of the back of the internal corner trim.



FOURTEEN

Repeat the steps used for walls 1 and 2 to complete wall 3 and the second section of wall 4 up to doorway point B, leaving enough space for the final panel above the door.

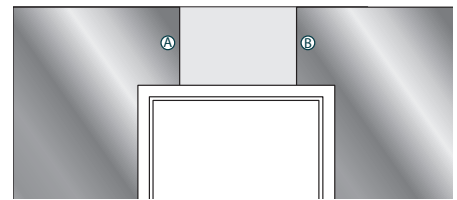

FIFTEEN

Measure and cut the final panel to fit above the door, trimming it to height and removing the right-hand groove for width. Ensure a clean, straight cut. Dry fit to check accuracy, then remove it ready for fixing with suction grips.

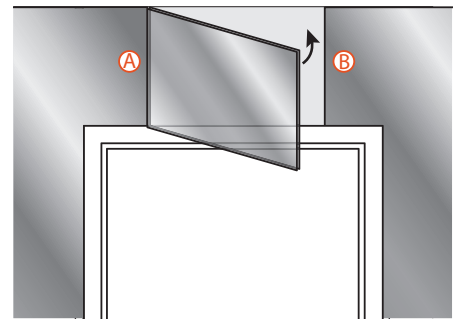

SIXTEEN

Apply adhesive to the wall. Apply sealant to the left-hand ProClick profile, as in step 6. Add a bead of sealant into the groove of the previously installed right-hand panel, ensuring it slightly overflows the edge. Fit the ProClick profile into the left-hand panel (A) ensuring a flush joint on the right (B).



SEVENTEEN

Immediately clean any sealant overspill from the joint and panel face. Seal the top and bottom of the installation as outlined in Section 3. Allow adhesive and sealant to cure for 24 hours. After installing your shower cubicle, clean the panels with non-abrasive cleaner.

ProClick Panels

JOINING TRIMS

Fix the joining trim with adhesive as described for all trims. Fill all trim recesses with sealant before panel installation, ensuring the panel edge is fully sealed when inserted.

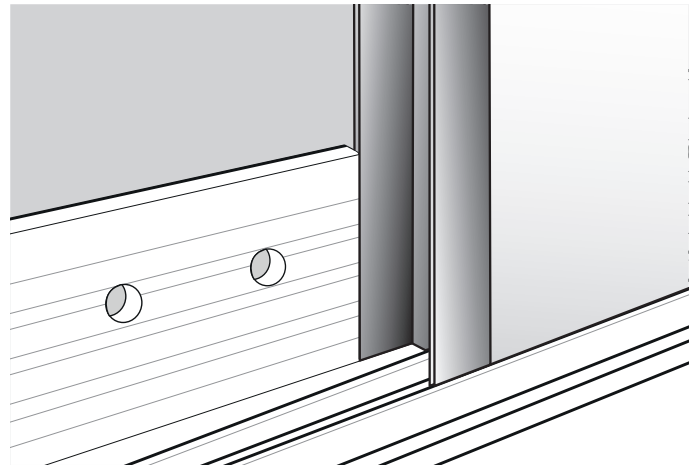

EXTERNAL CORNERS

For 90° wall returns or pipe boxing, use internal and external corner trims. The external trim and cut panels may need to be assembled as one unit and fitted into the internal corner trims to complete the installation.

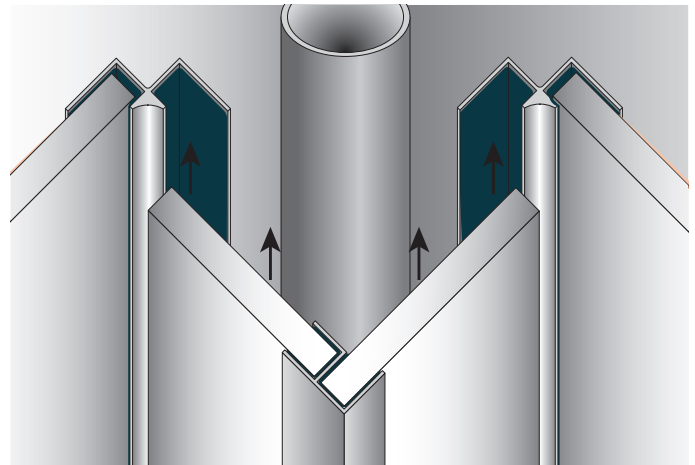

Fix all trims with adhesive and fill trim recesses with sealant before installing the panels.

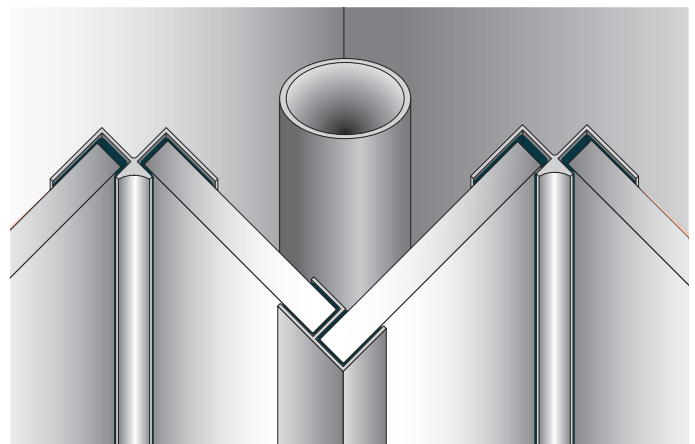

ProClick Panels

WINDOW REVEALS

Use external trim for each external corner point around your window reveal.

Ensure all trims are fixed with adhesive and all trim recess are filled with sealant prior to installing the panel sections.

Measure and cut the final panel sections ready for installation. Dry fit each section to ensure correct angles, sizes and a neat fit.

Measure and compound mitre cut each section of external corner trim as required. Ensure the trim is placed in the mitre box correctly so that the correct compound angle is achieved.

Once the trims have been correctly mitre cut to length and checked for accurate fitting, fix the trims in place using adhesive in the same manner previously detailed.

Next, apply adhesive to the window reveal wall sections in the same manner as detailed in step 4 of section 3.

Install the top and bottom horizontal panels first by angling them into the trim recess, then pressing firmly onto the adhesive.

Install the two vertical side panels using the same method. Finish by applying sealant as needed.

Finish by applying sealant to the top and bottom joints and rear edges where the panels meet the window frame.

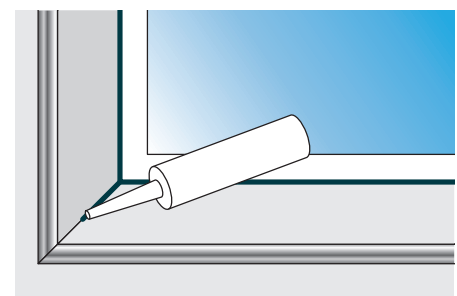
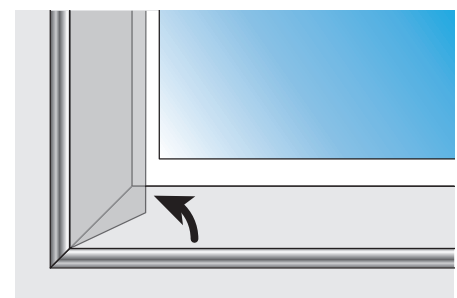
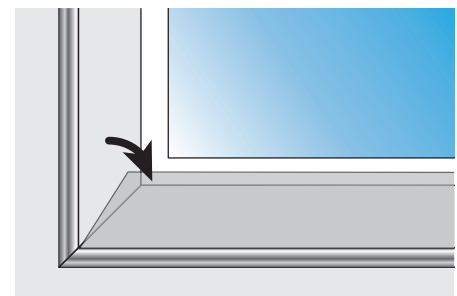
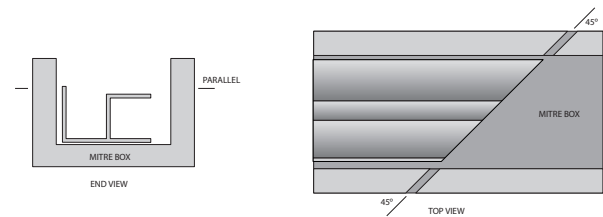
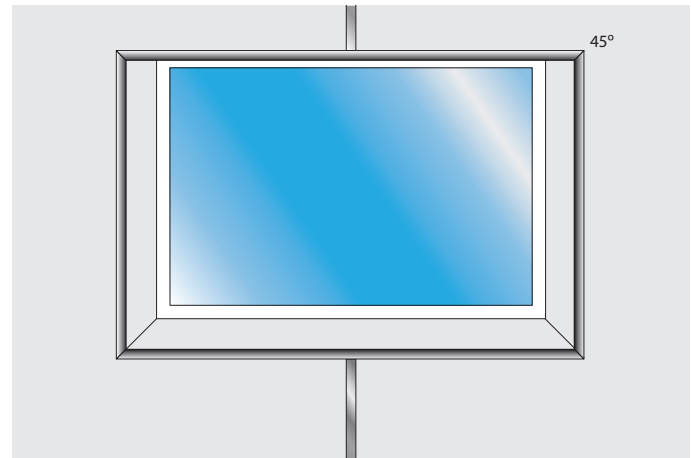

Care, Maintenance & Guarantee Details

CARE

Our non-porous surface resists bacteria and is easy to clean.

Use a non-abrasive, pH-neutral cleaner

- Rinse panels after each shower
- Clean regularly
- Avoid leaving chemicals like hair dye or bleach on the surface, as they may discolour the sealant

Please ensure the property owner retains this section for future reference.

MAINTENANCE

Exposed bottom edge sealants may need periodic replacement due to normal wear and shower use. Regular maintenance is essential to prevent water ingress and panel damage, which would void the guarantee.

GUARANTEE

Crosswater panels are guaranteed against manufacturing defects for:

- 30 years in domestic installations (if registered within 28 days of installation)
- 15 years in domestic installations (if not registered within 28 days)
- 5 years in commercial installations

The guarantee is only valid if installation follows the official instructions. It does not apply to bespoke or non-standard installations.

The full guarantee document is available on the website or upon request.

INSTALLATION DATE	PANEL BATCH NO.
<hr/>	<hr/>
<hr/>	
INSTALLER DETAILS	
<hr/>	



Naturally Inspired Surfaces

0345 873 8840

crosswater.co.uk | 2025-V1