

WLBP3001R+ - 3Outlet Thermo Valve NO COLLARS Landscape

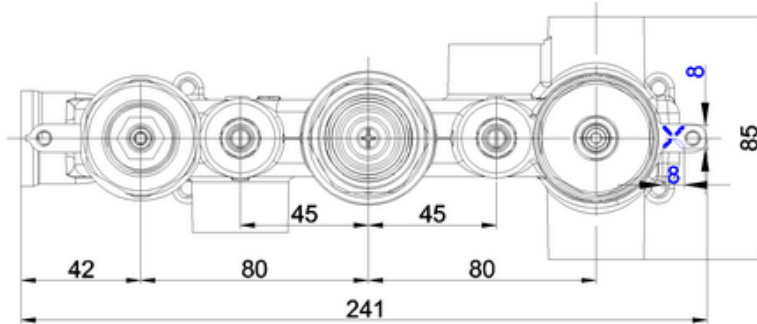

Note:

For the each part, the dimension tolerance should be followed the list below.

0 ~ 100	101 ~ 200	201 ~ 400	≥401
±1	±2	±3	±5

For the finished assembly, the dimension tolerance should be followed the list below.

0 ~ 300	≥301
±2	±5

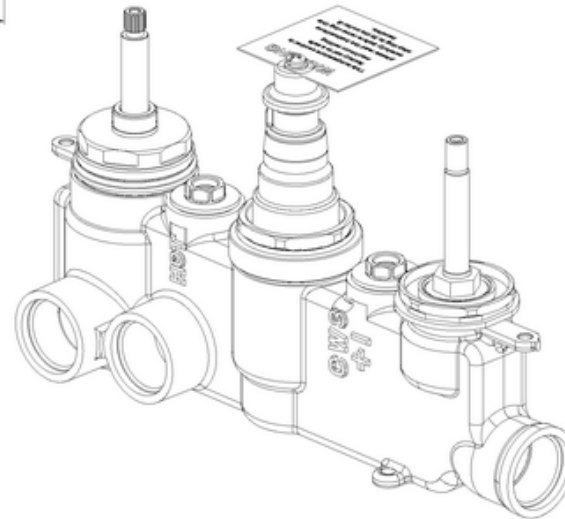
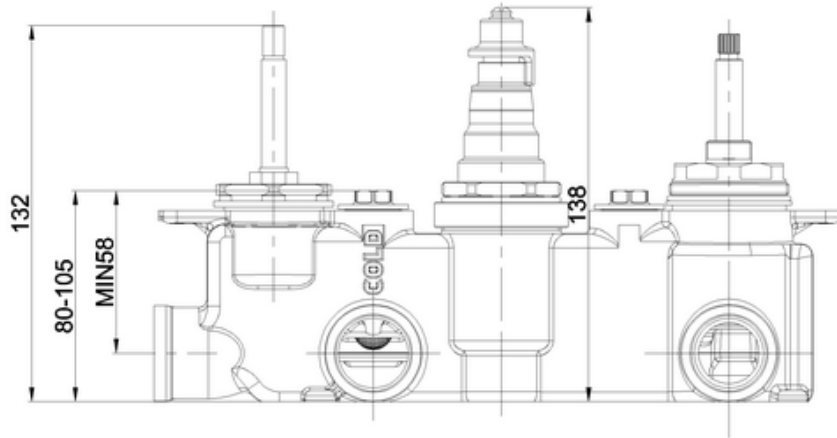

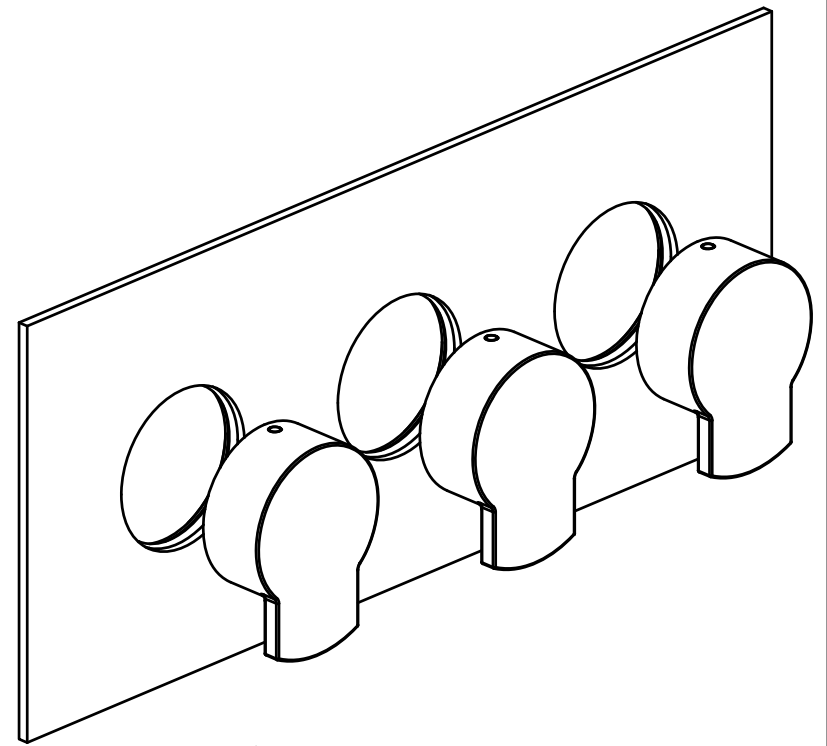
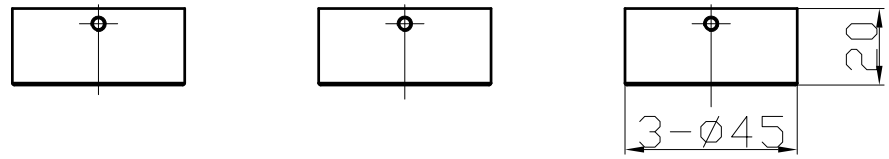
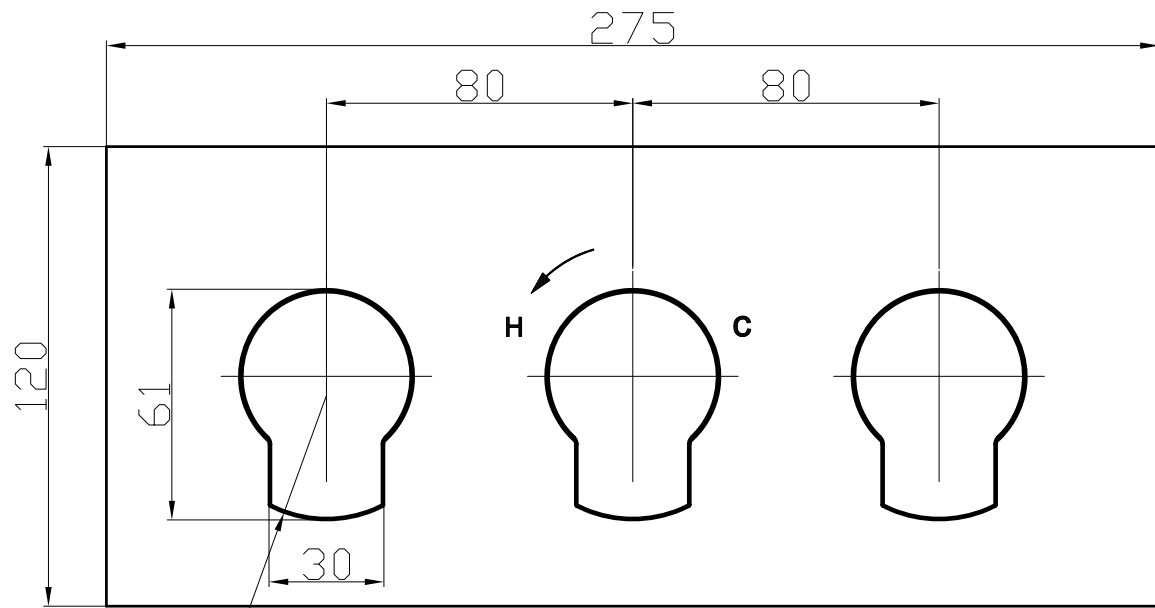

WP2001LBPC