

Optix 10 Pivot Door

Manufactured to: BS EN 14428

IMPORTANT

BEFORE STARTING THE INSTALLATION ENSURE ALL THE DOOR SIZE MEASUREMENTS CORRESPOND WITH THE INSTALLATION AREA INCLUDING THE FINISHED TILED/PANELLED WALLS.

RETURNS DUE TO INCORRECT SIZING WILL NOT BE ACCEPTED.

OXWPSC0800	47Kgs
OXWPSC0900	53Kgs
OXWPFC0800	47Kgs
OXWPFC0900	53Kgs
OXWPVC0800	47Kgs
OXWPVC0900	53Kgs

OXWPSPSC0800	47Kgs
OXWPSPSC0900	52Kgs
OXWPSPFC0800	47Kgs
OXWPSPFC0900	52Kgs
OXWPSPVC0800	47Kgs
OXWPSPVC0900	52Kgs

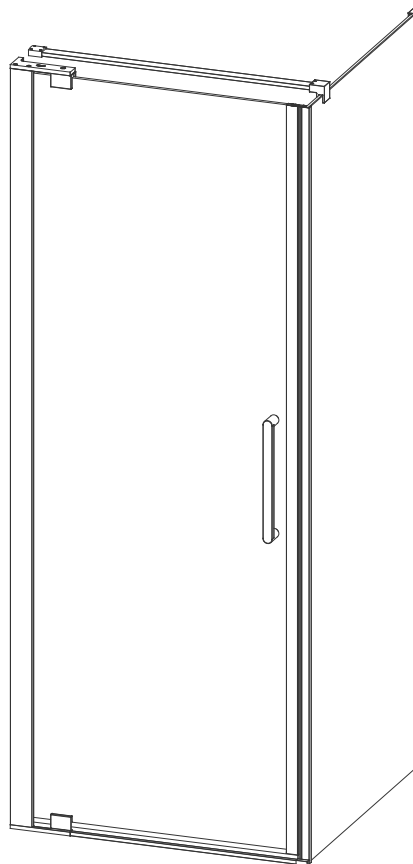
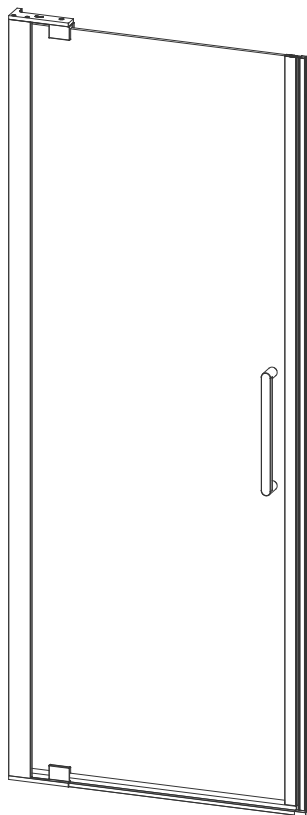

Optix 10 Pivot Door

Optix 10 Side Panel for Pivot Door

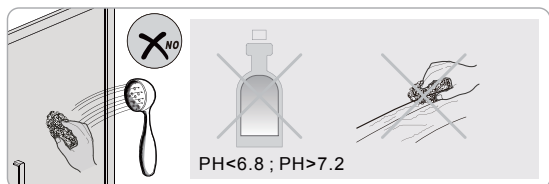
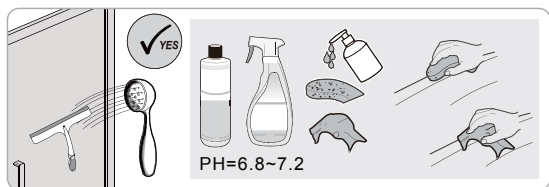

INSTALLATION INSTRUCTIONS

crosswater[®]
SHOWERING

IMPORTANT - Please read before installation

Please read these instructions carefully before starting installation and keep in a safe place for future reference.

Check the contents of the pack carefully before installation. Crosswater will not be held responsible for any de-fit / re-fit costs where faulty product has been fitted.

If any fault is found with materials or workmanship, it must be reported immediately to the manufacturer. Remedial action will be taken, based on information received, on condition that:

1. Full details are supplied to the manufacturer;
2. The enclosure has not been modified or tampered with;
3. The manufacturer is informed of any damage/shortages prior to installation.

We do not accept responsibility for any problems that may occur through incorrect installation.

The success of the installation and operation of any shower enclosure is, of course, dependant on the squareness, alignment and construction of the walls to which fixing is to be carried out.

VERY IMPORTANT

You must complete all tiling and grouting, and the shower tray **MUST** be level and fully sealed to the tiles before installation. If you do not fit the enclosure onto a tiled surface, or seal the tiles to the tray before installation, water may soak into the wall behind the wall profiles.

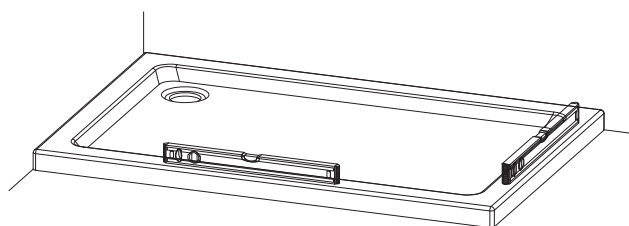

INSTALLATION - Advise and safety

The installation instructions are based on typical use and conditions.

All doors are designed to open outwards only.

These hints have been prepared for your guidance, you must exercise due care at all times.

For Health and Safety 2 people must carry out the installation of this enclosure.

Handle glass with care. Although the glass supplied is toughened safety glass(EN12150), impacts can damage both the glass and the frame.

Warning!

Please check for any hidden pipes or cables before drilling holes in the wall.

When using power tools always follow the manufacturers user instructions.

If the Framework is sealed to the tray on the inside, any water that may get into the framework will not be able to drain back into the tray, this may cause the enclosure to leak.

Leave the silicone sealant to dry for 24 hours before using the enclosure.

CARE AND CLEANING

Do not use solvents or abrasive material or chemicals to clean the enclosure.

Only clean using soapy water and soft cloth, rinse thoroughly afterwards.

INSTALLATION - Left and Right hand

This product is reversible for left or right hand opening.

Please follow the diagram, and detail below for your choice of installation.

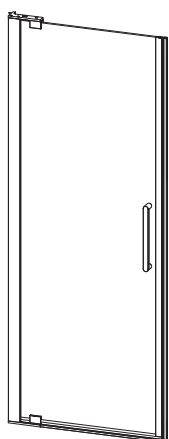

LH

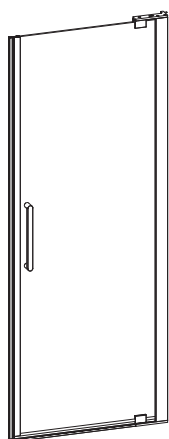

RH

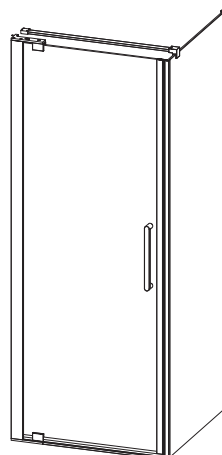

LH

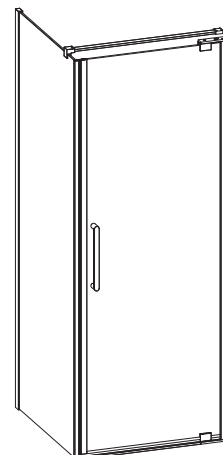

RH

Optix 10 Pivot Door

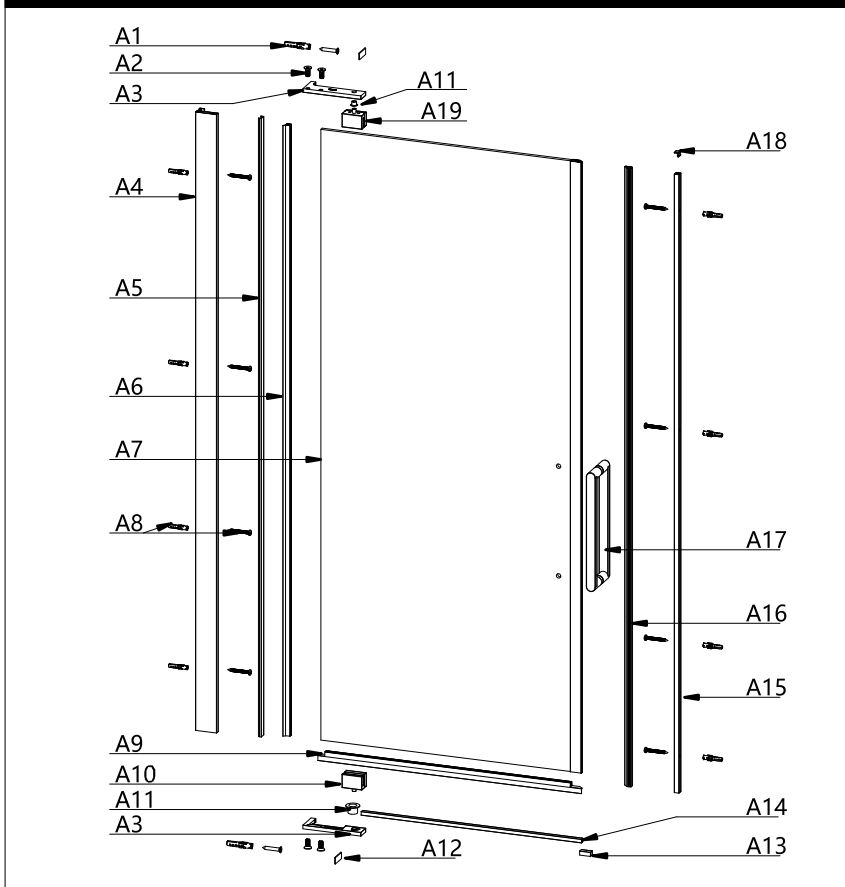

Optix 10 Side Panel for Pivot Door

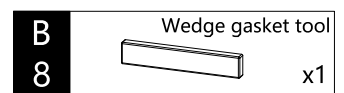
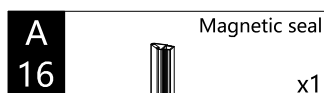
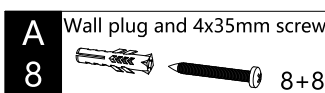
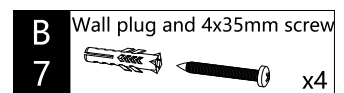
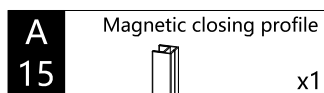
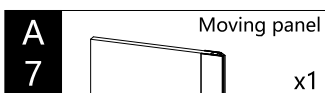
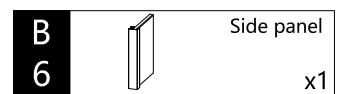
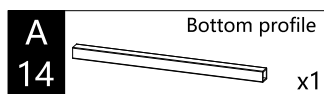
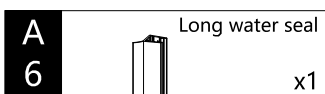
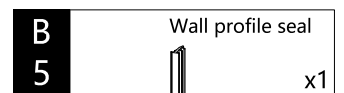
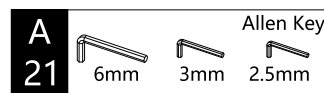
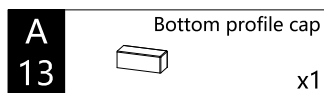
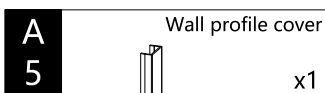
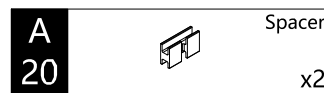
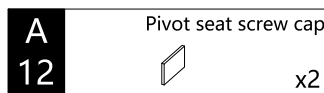
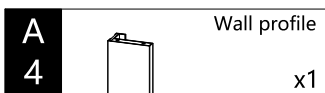
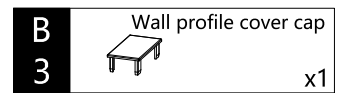
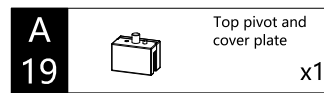
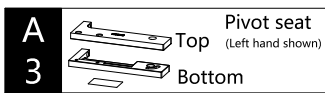
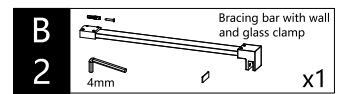
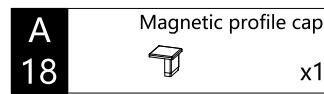
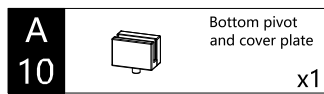
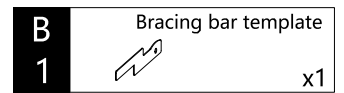
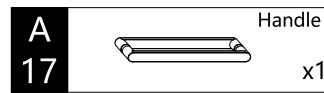
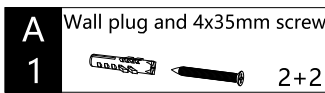
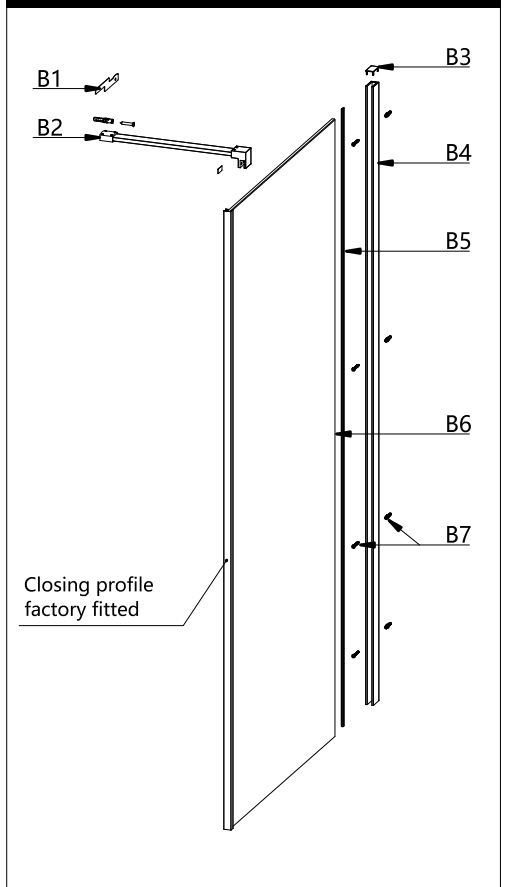

Installation tool

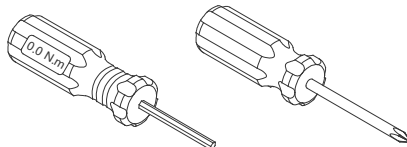
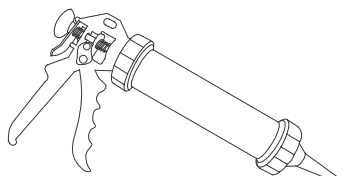
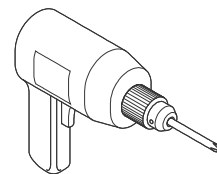
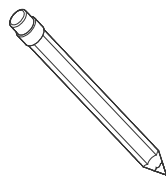
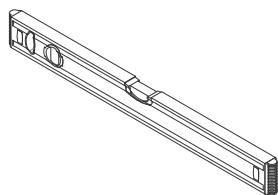

Torque screwdriver

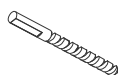

∅ 6.5

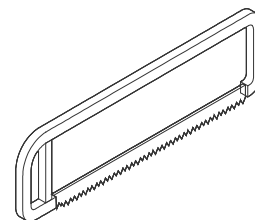
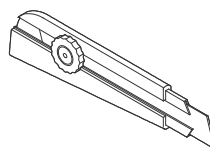
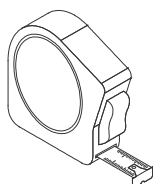

Step A1

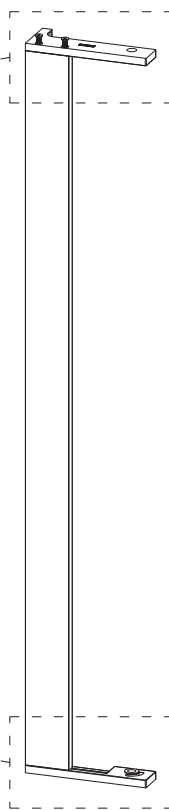
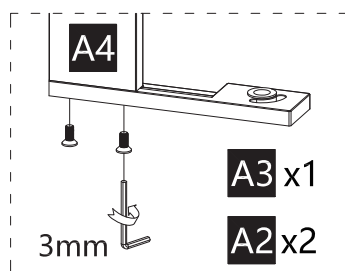
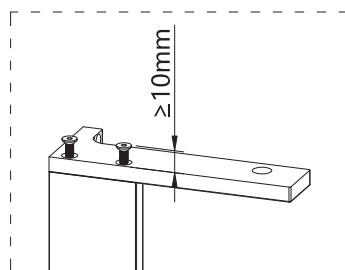
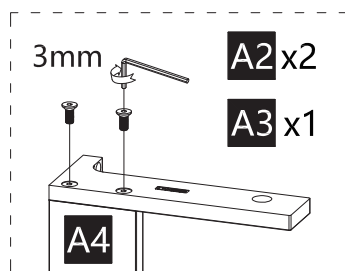

Step A2

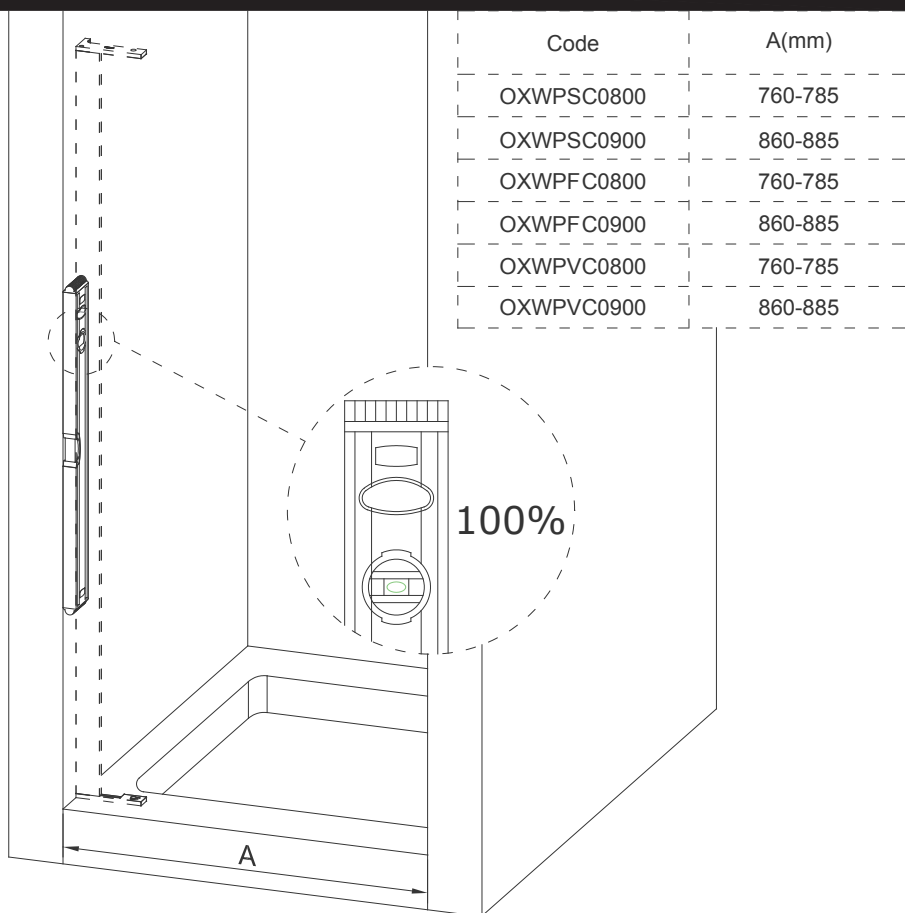
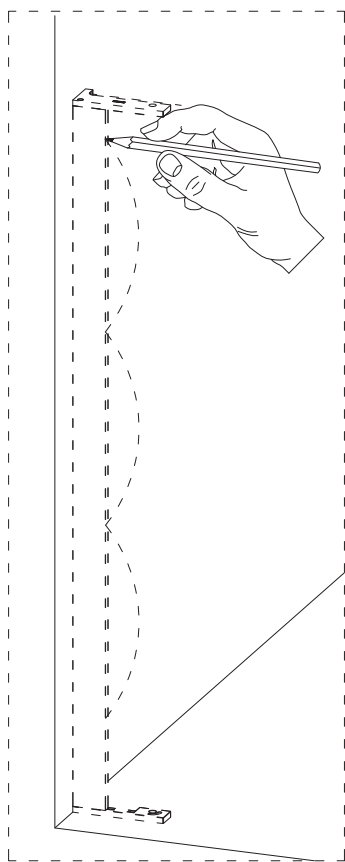

Code	A(mm)
OXWPSC0800	760-785
OXWPSC0900	860-885
OXWPFC0800	760-785
OXWPFC0900	860-885
OXWPVC0800	760-785
OXWPVC0900	860-885

Step A3

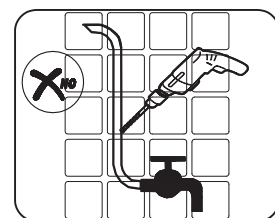
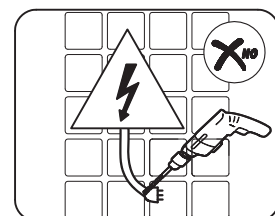
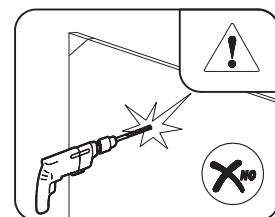
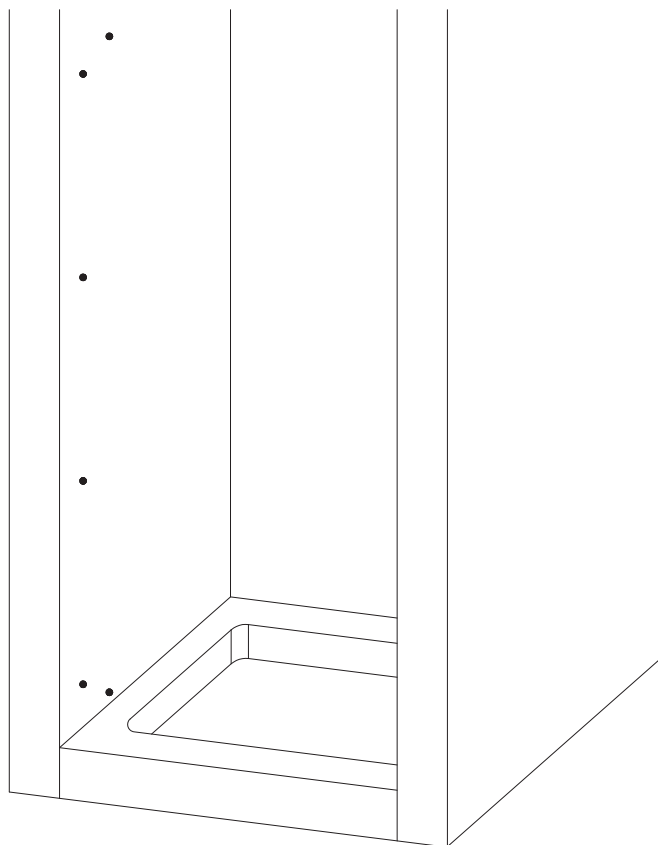
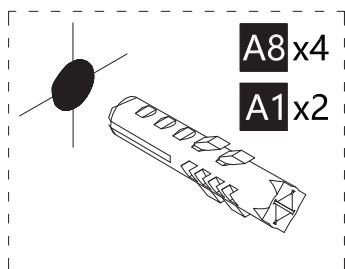
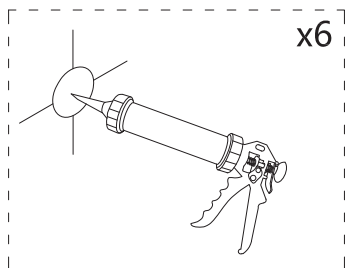
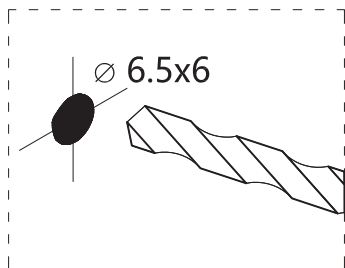

Step A4

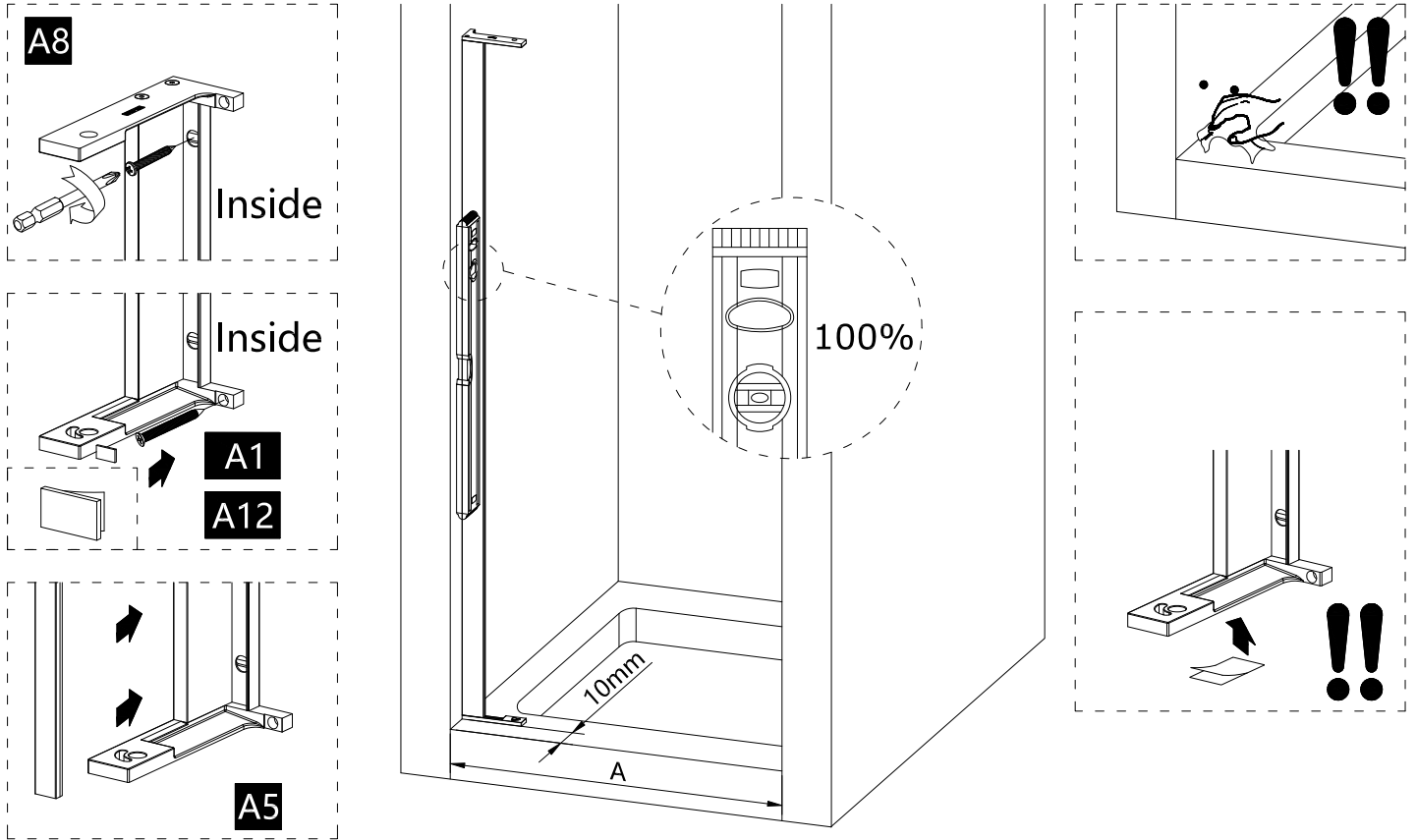

Step A5

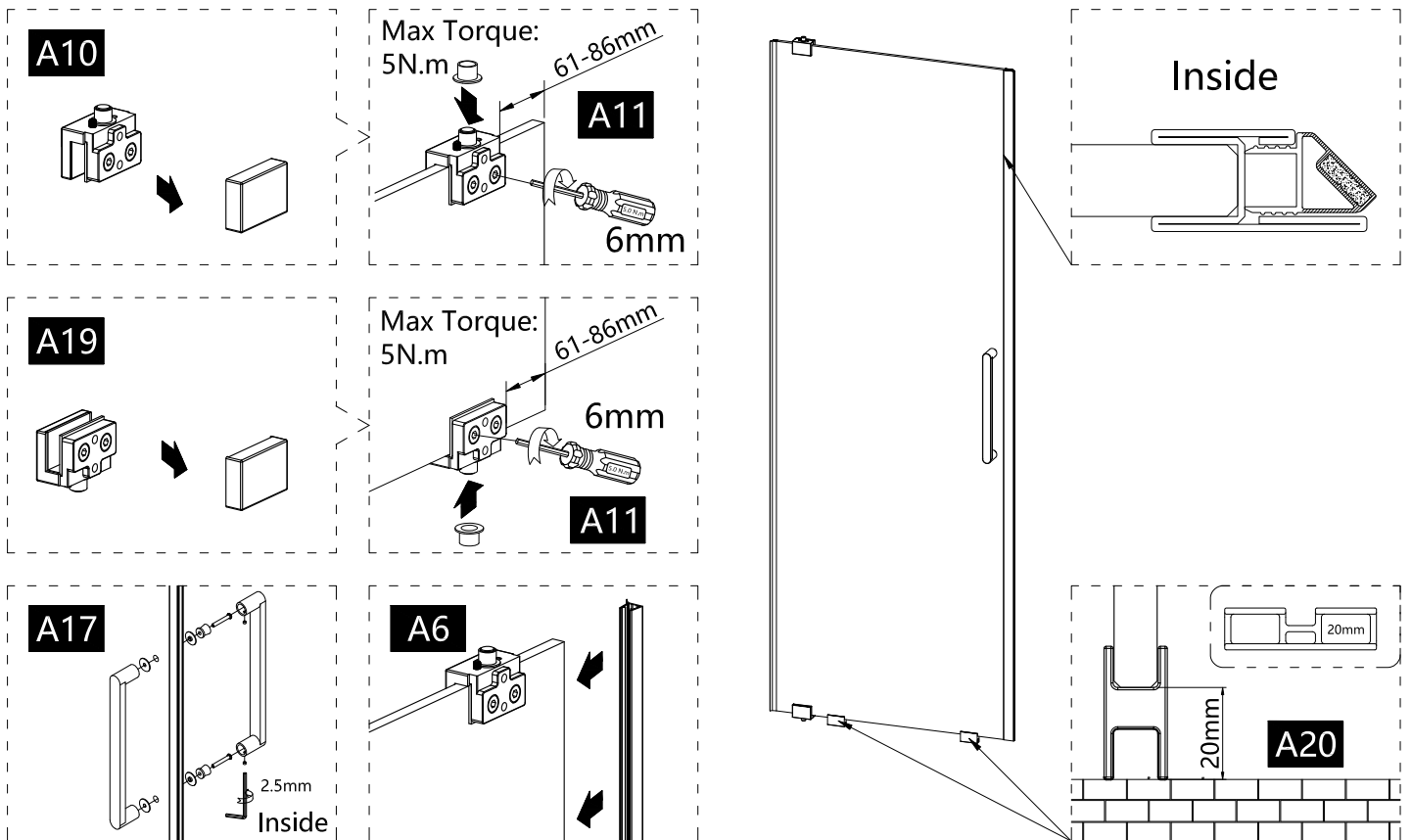

Step A6

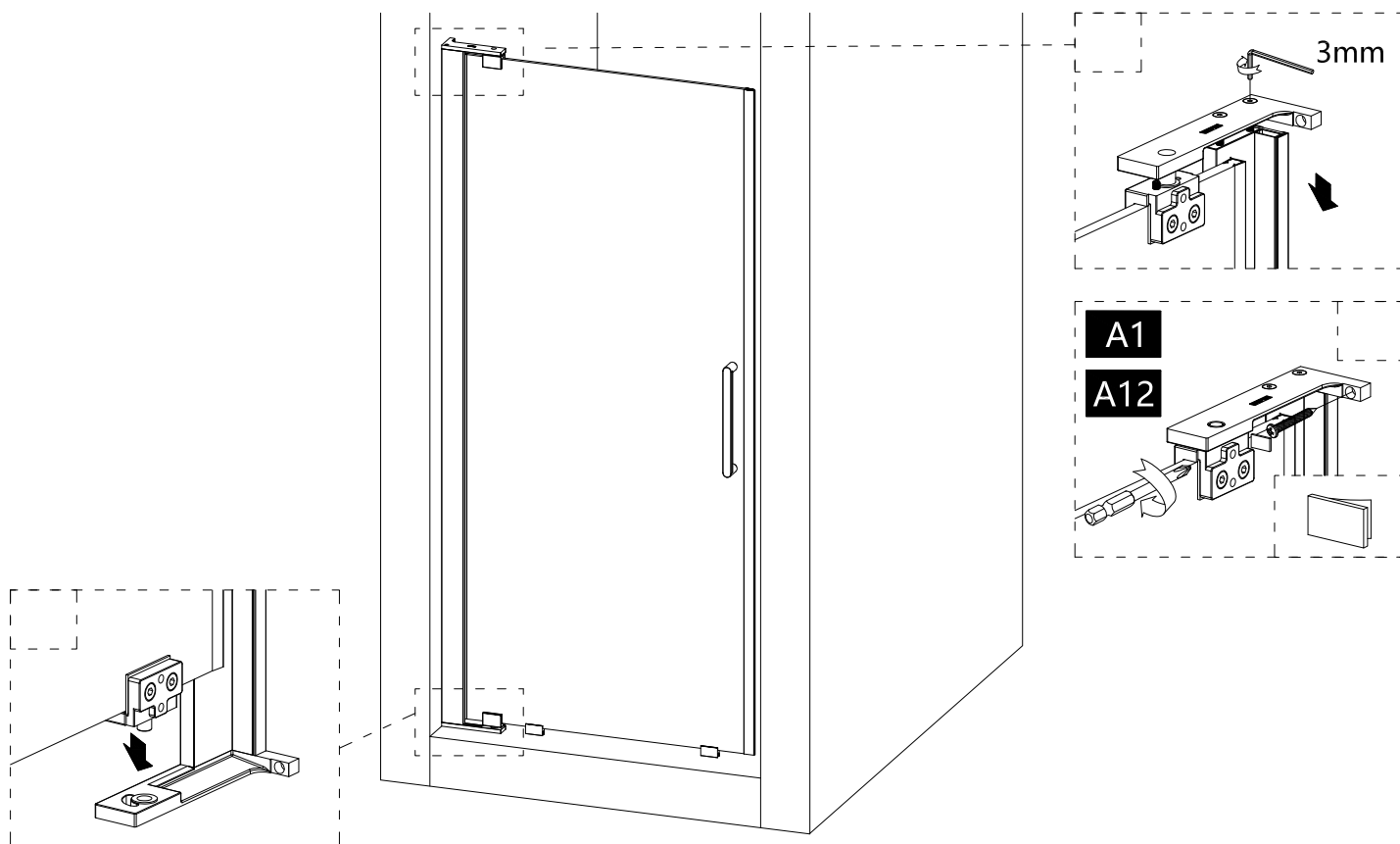

Step A7

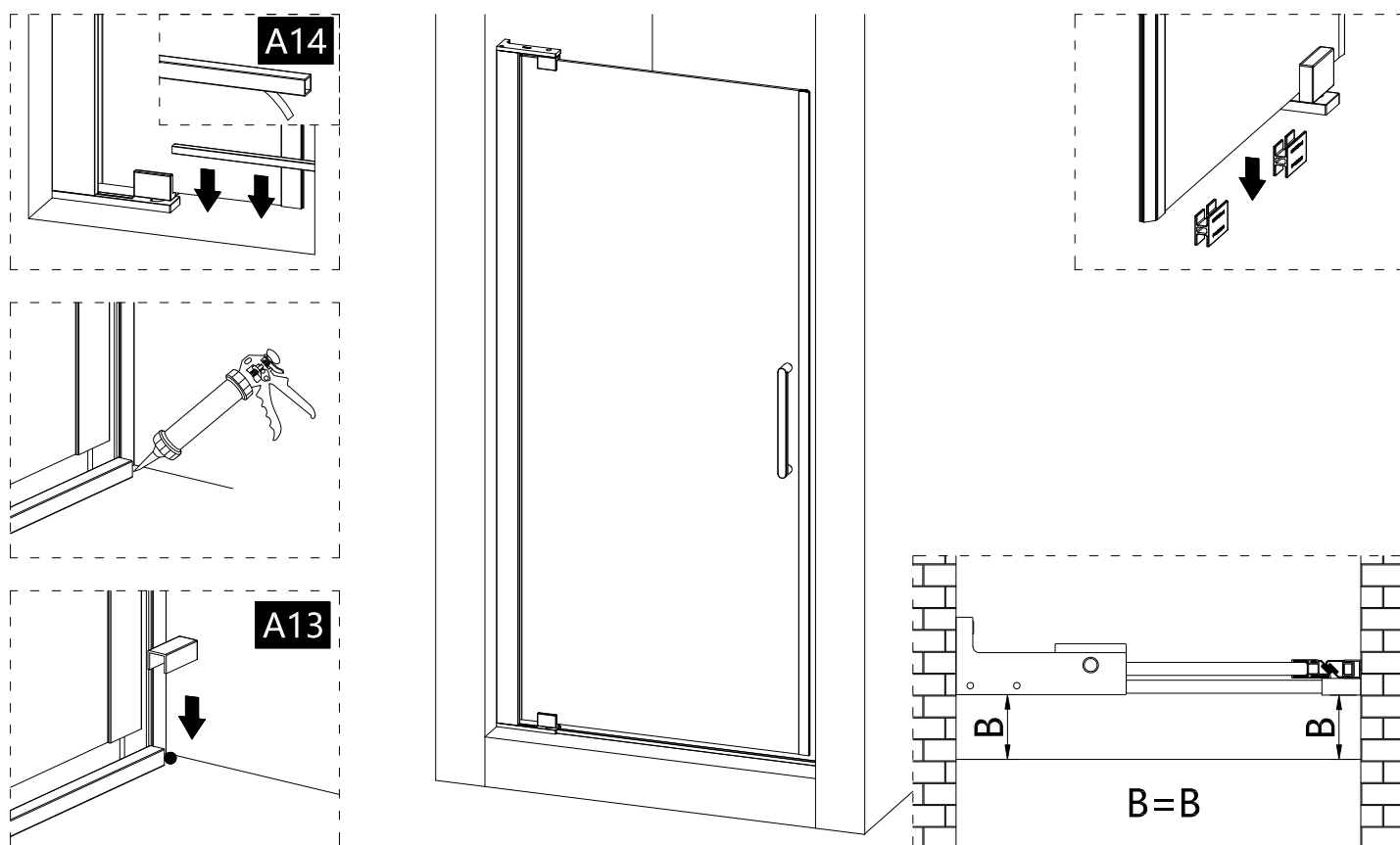

Step A8

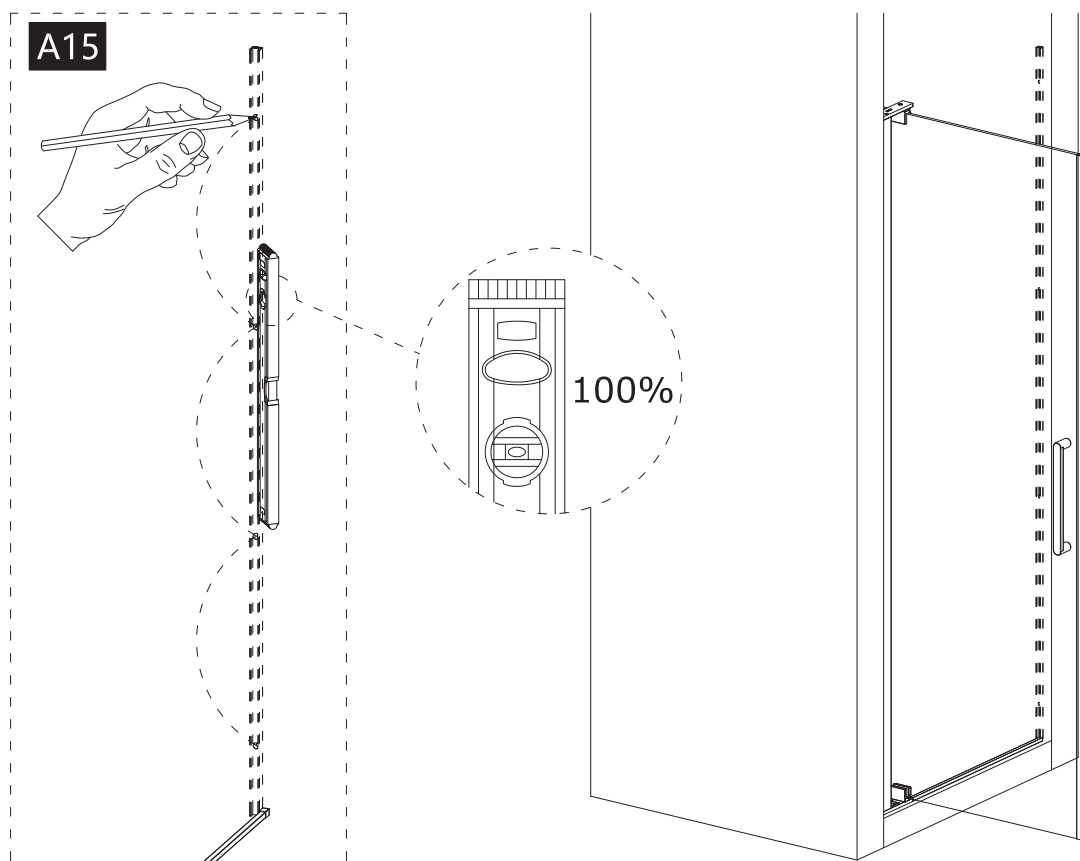

Step A9

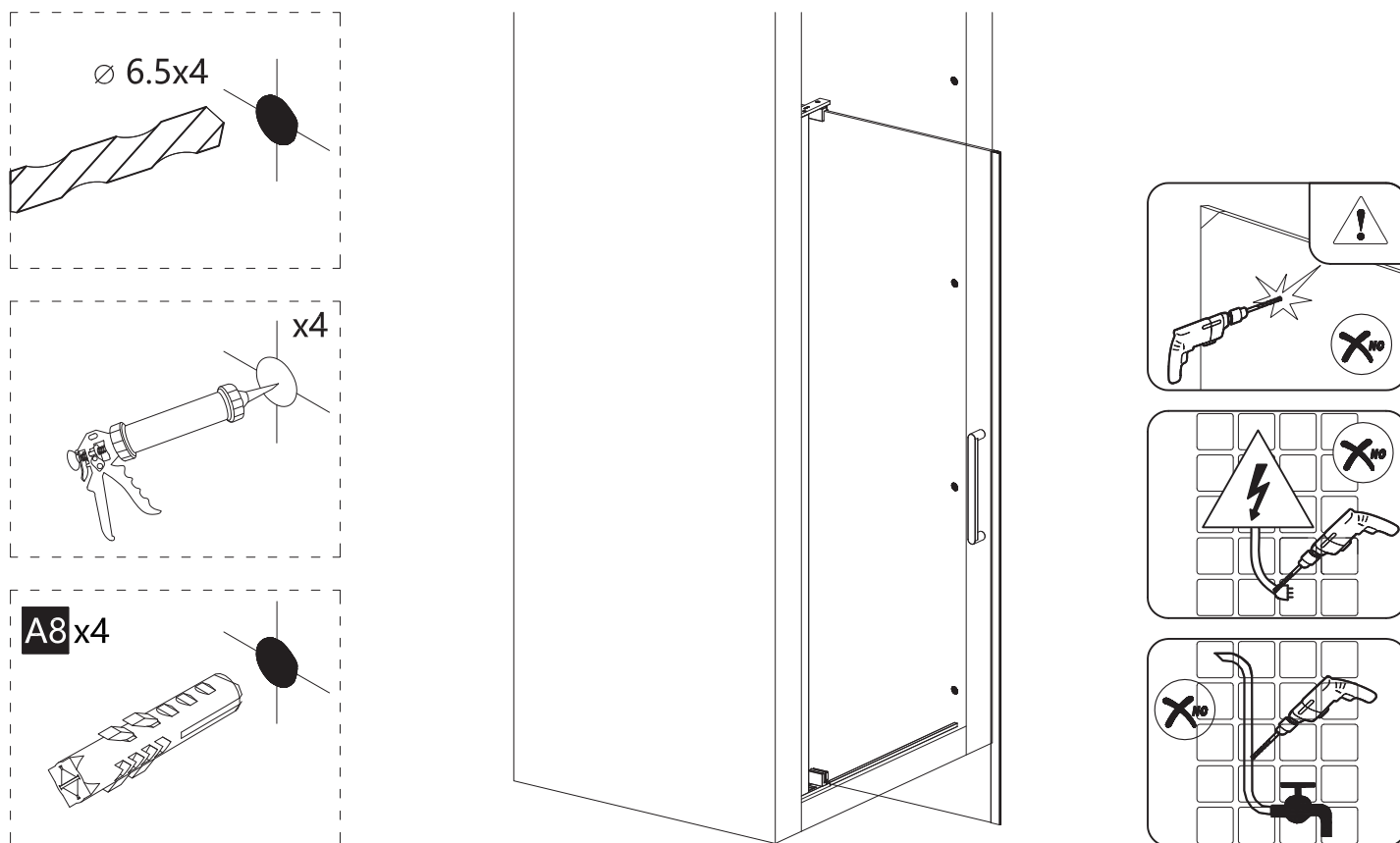

Step A10

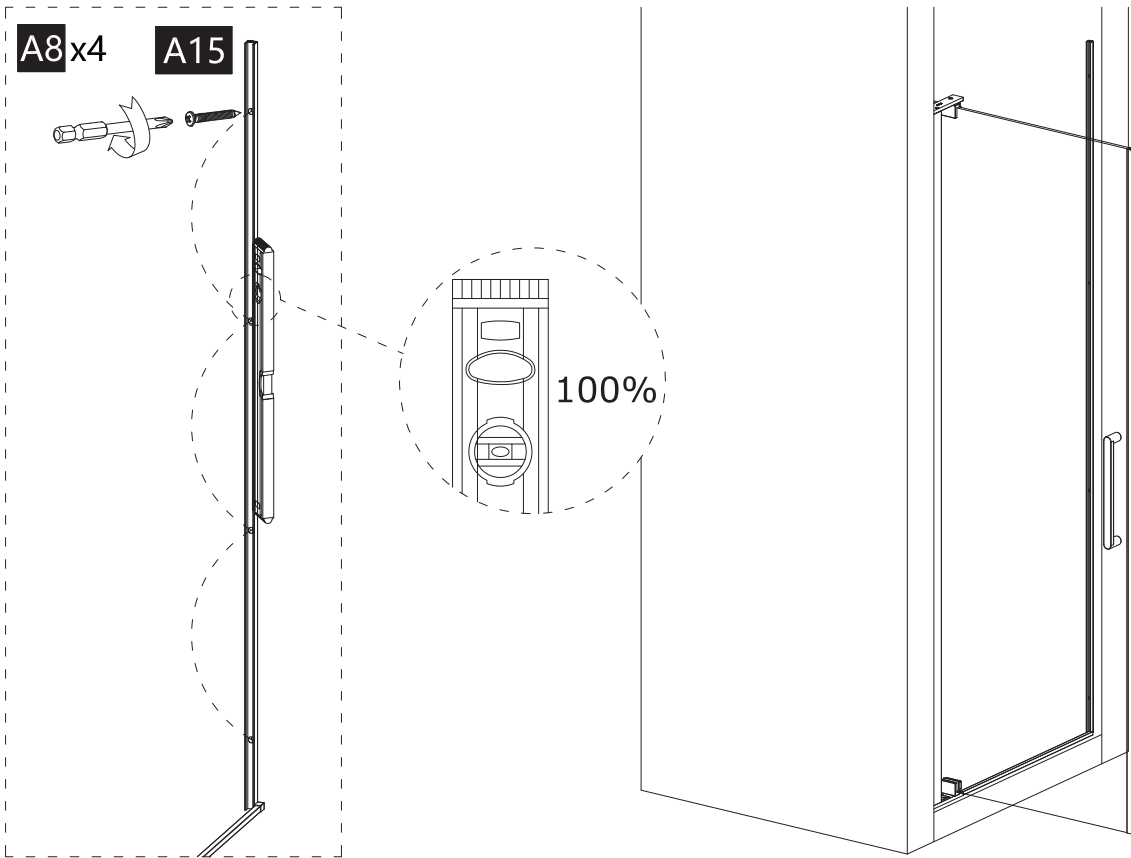

Step A11

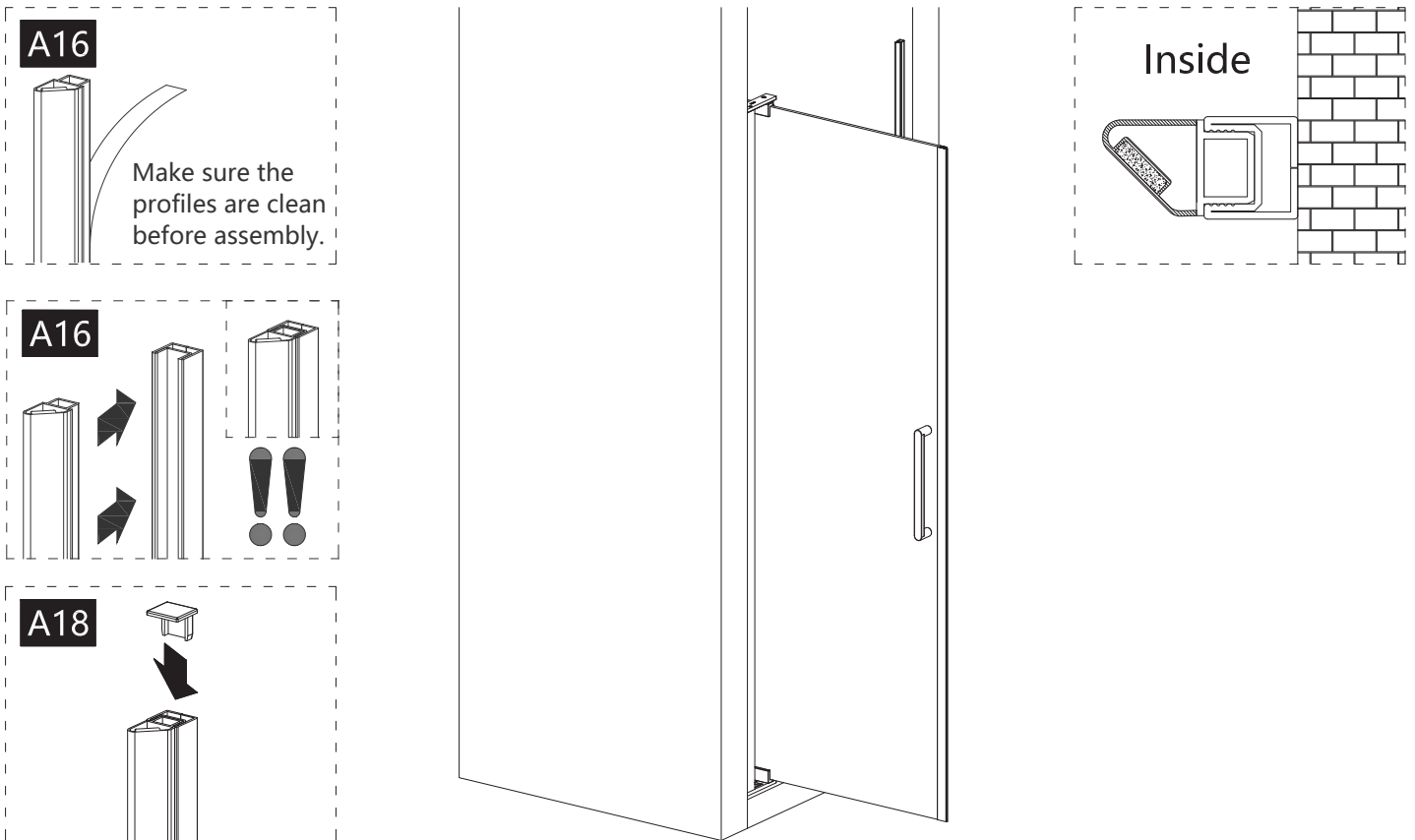

Step A12

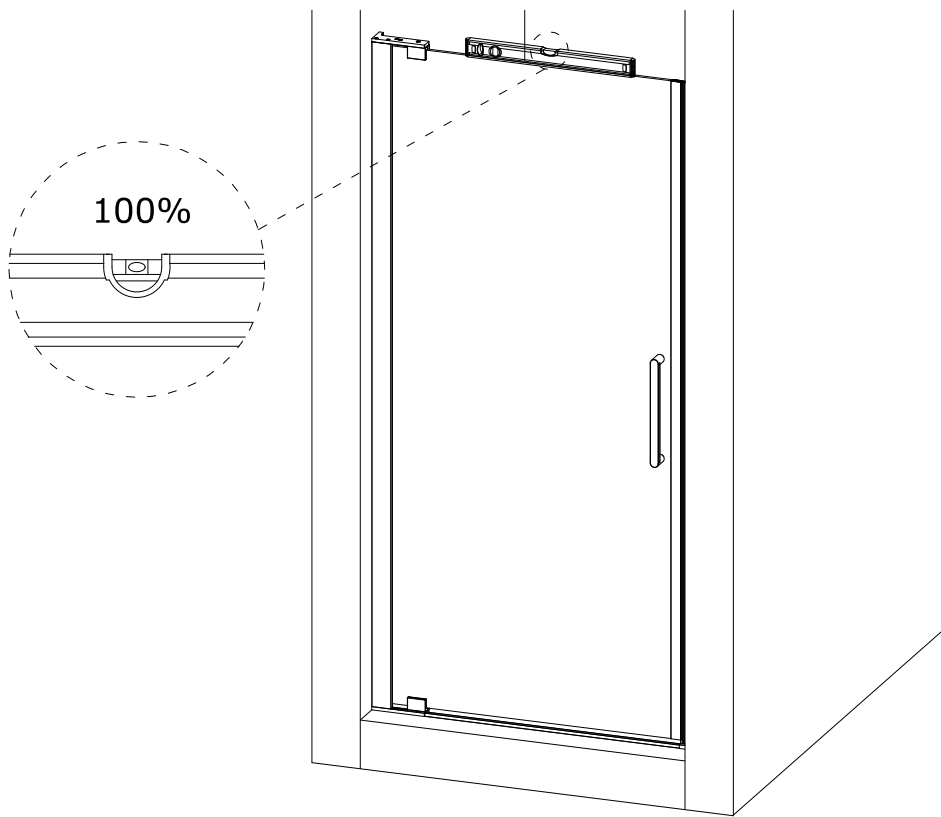
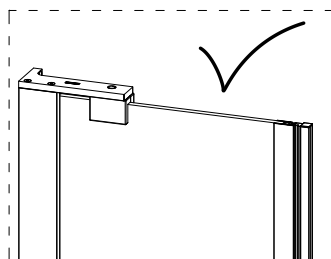
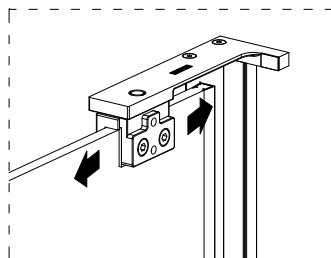
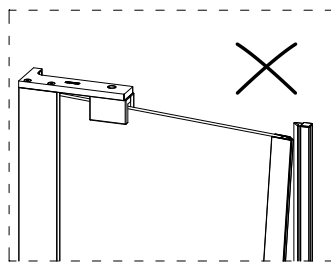

Step A13

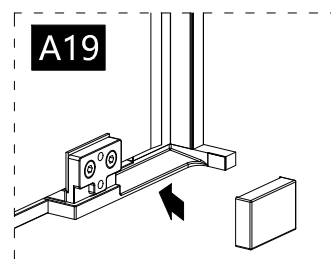
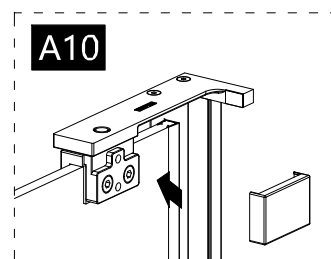
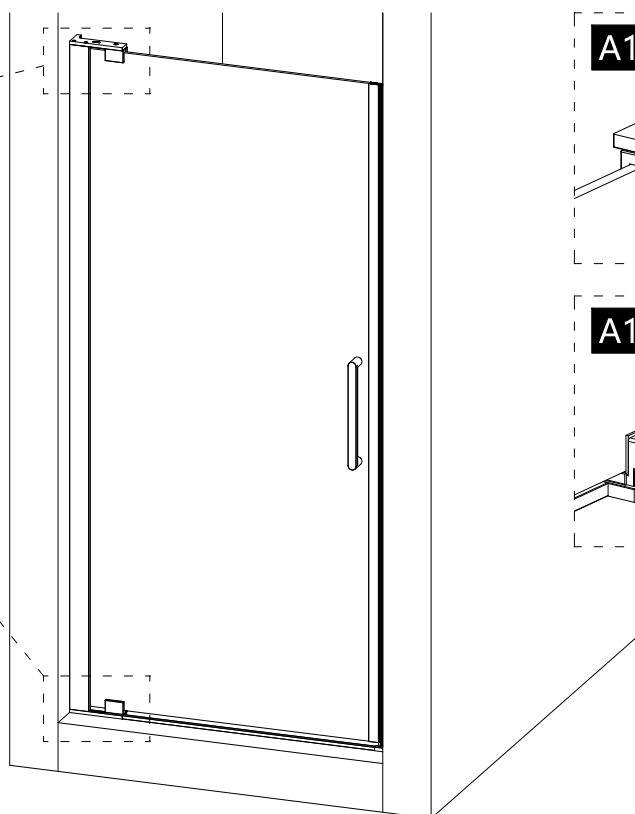
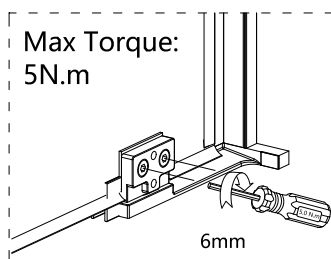
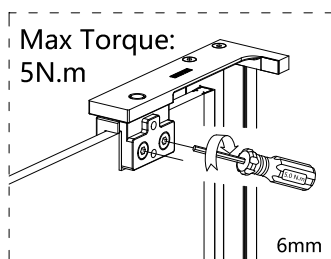

Step A14

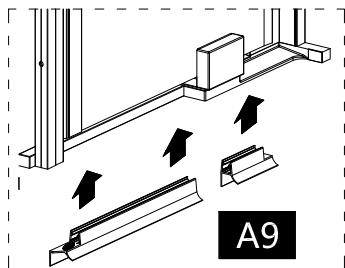
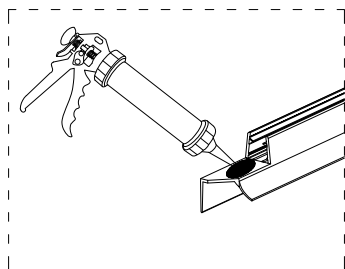
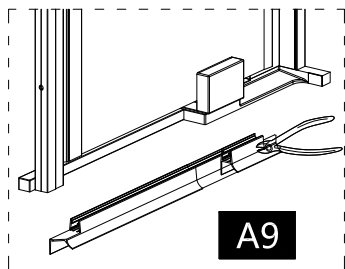

Step A15

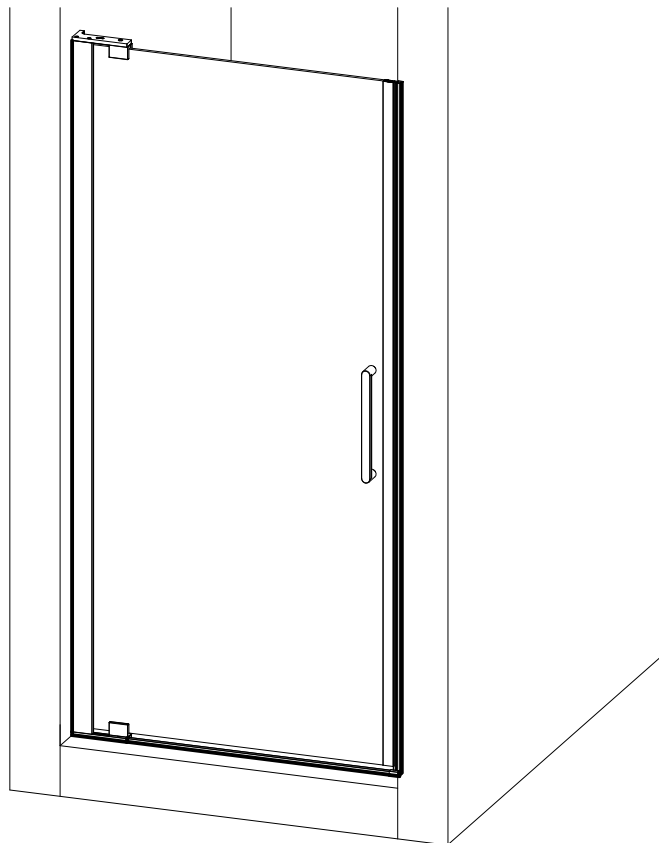
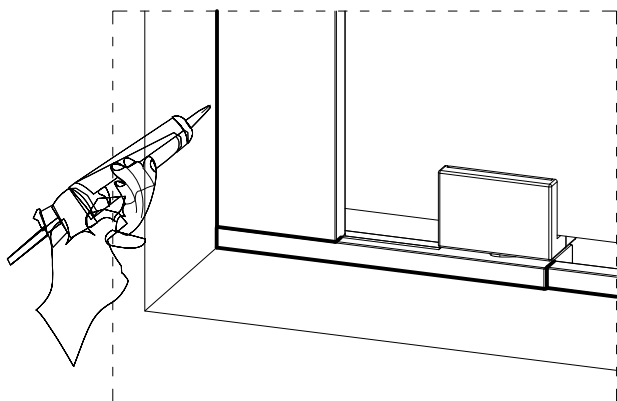

Step B1

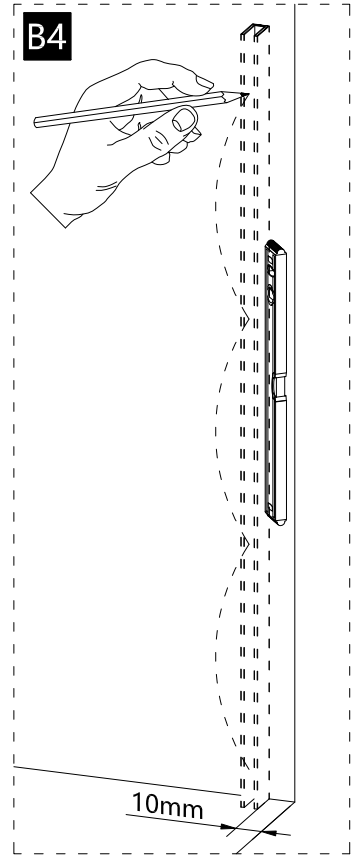
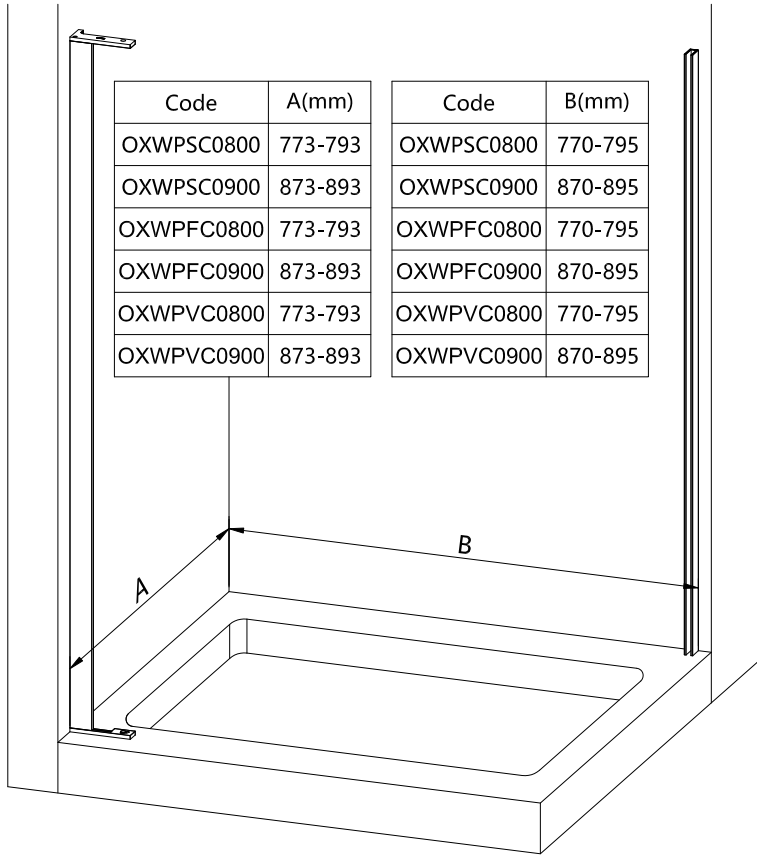

Step B2

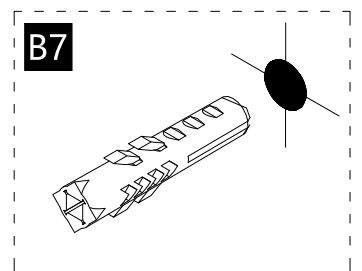
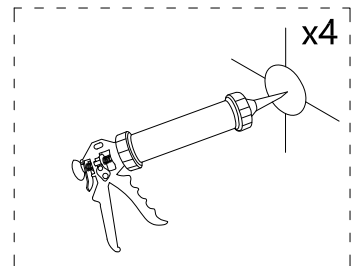
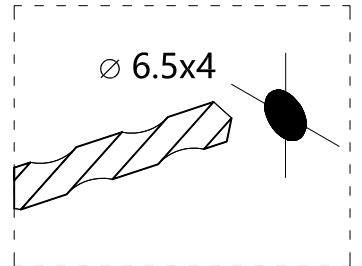
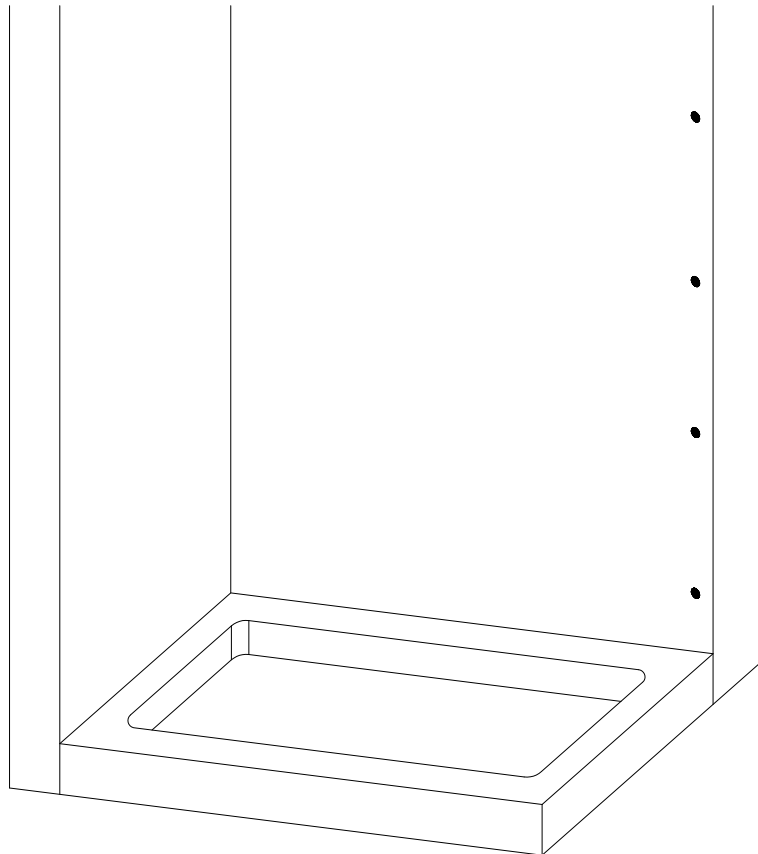
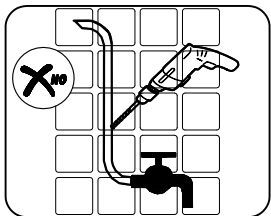
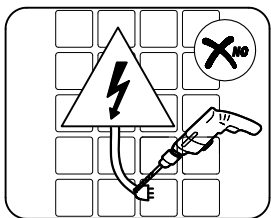
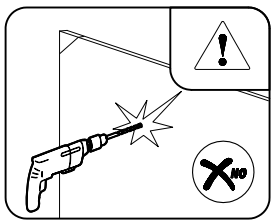

Step B3

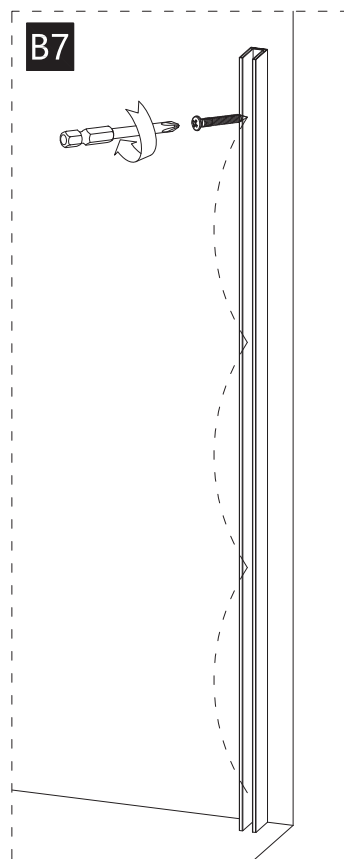
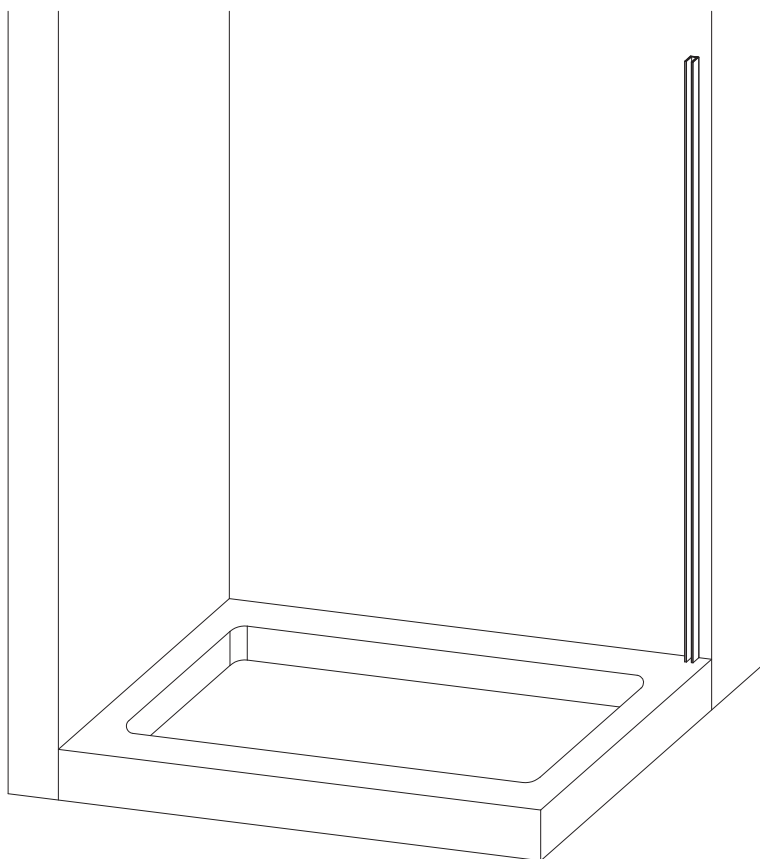

Step B4

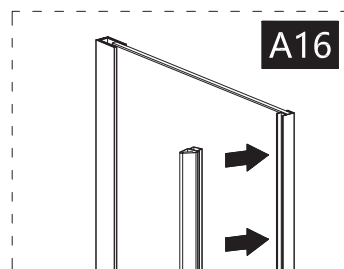
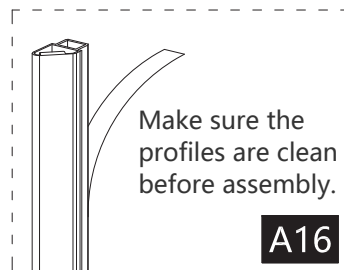
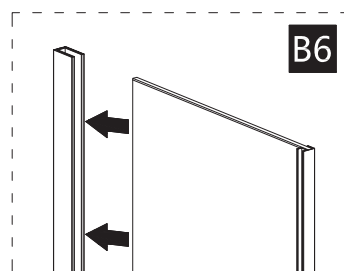
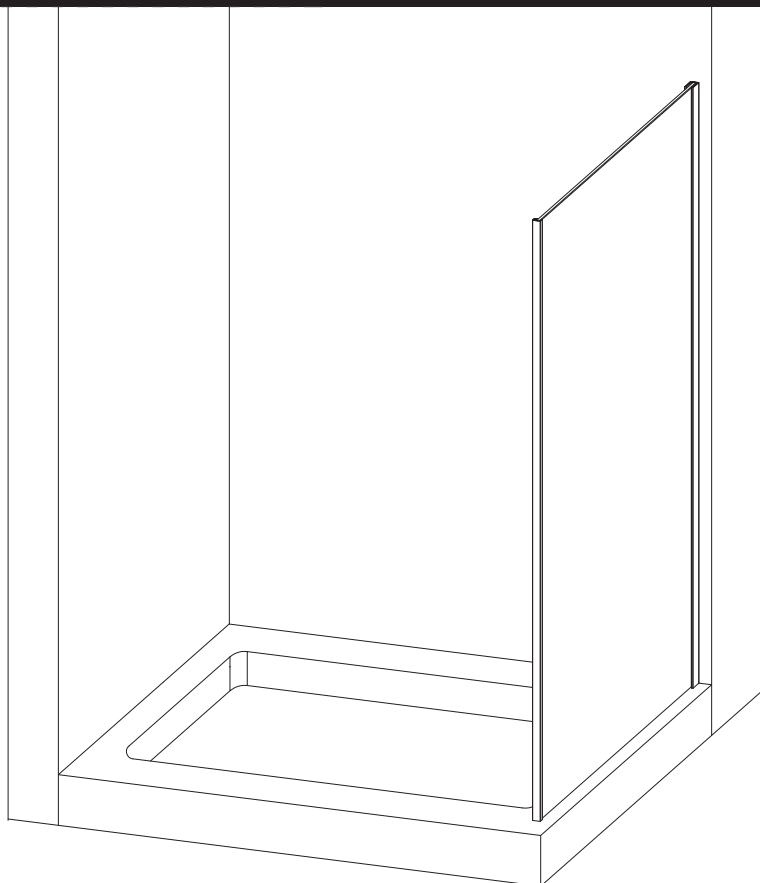

Step B5

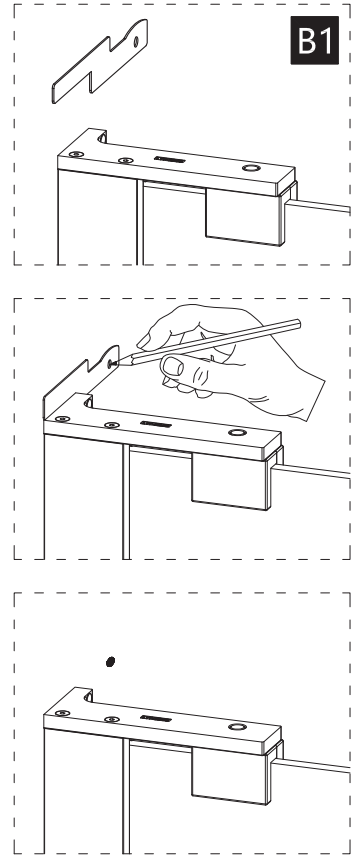
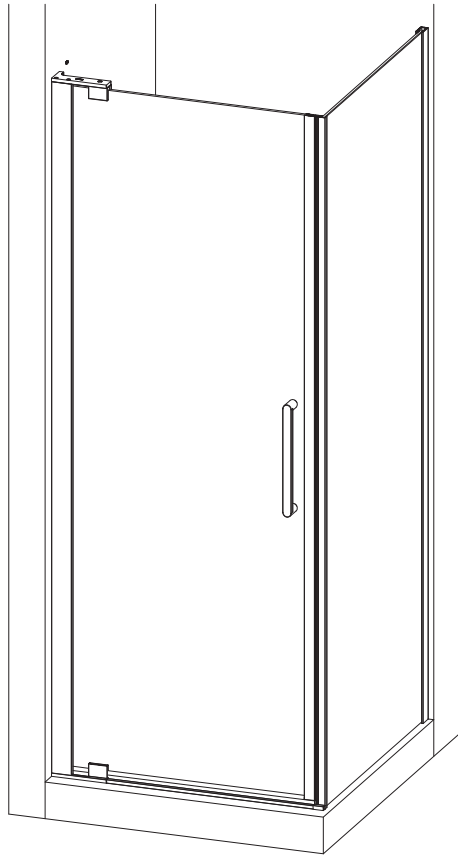

Step B6

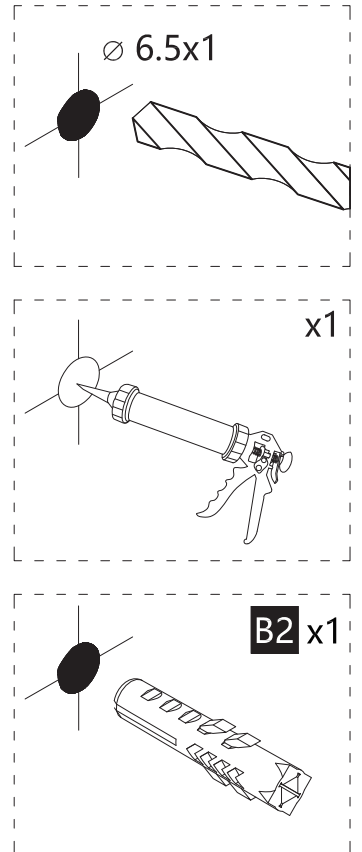
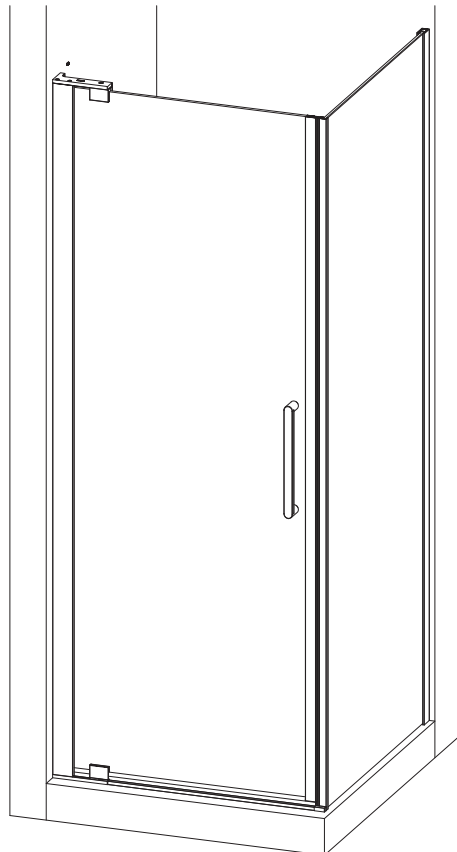
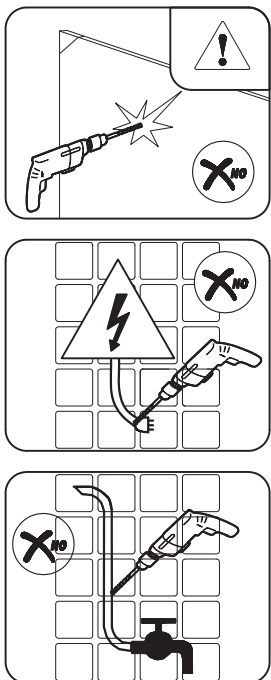

Step B7

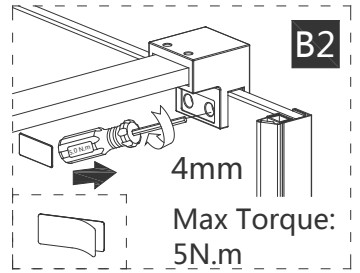
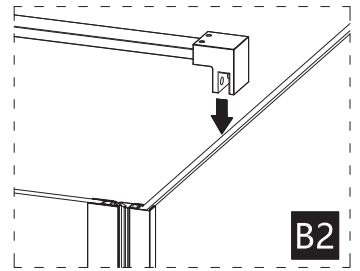
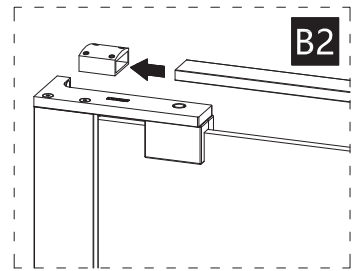
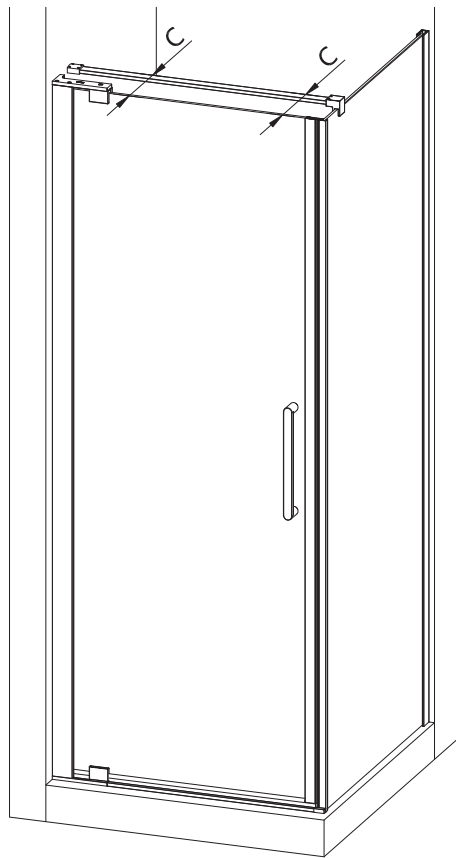
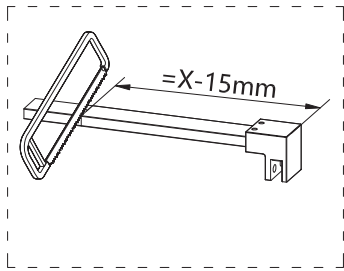
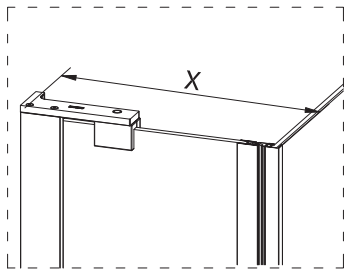

Step B8

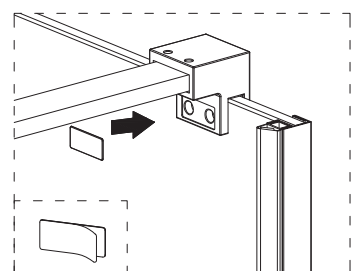
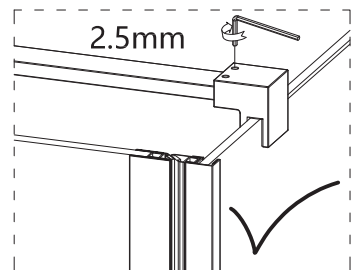
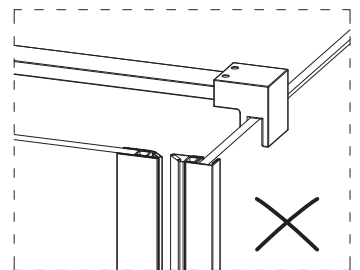
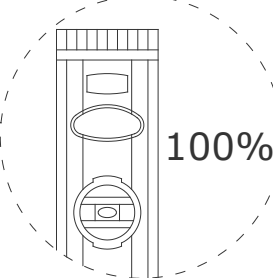
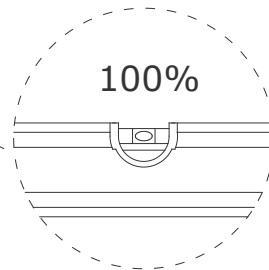
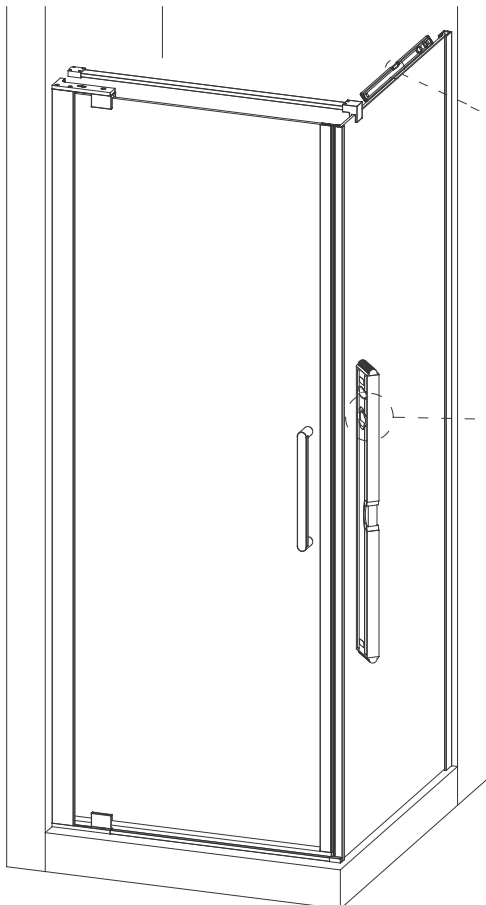

Step B9

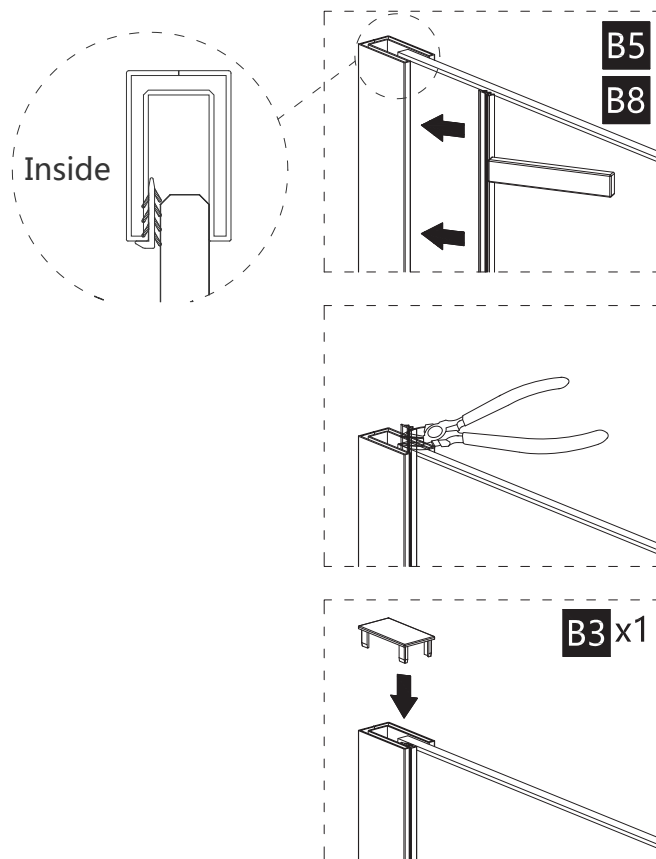
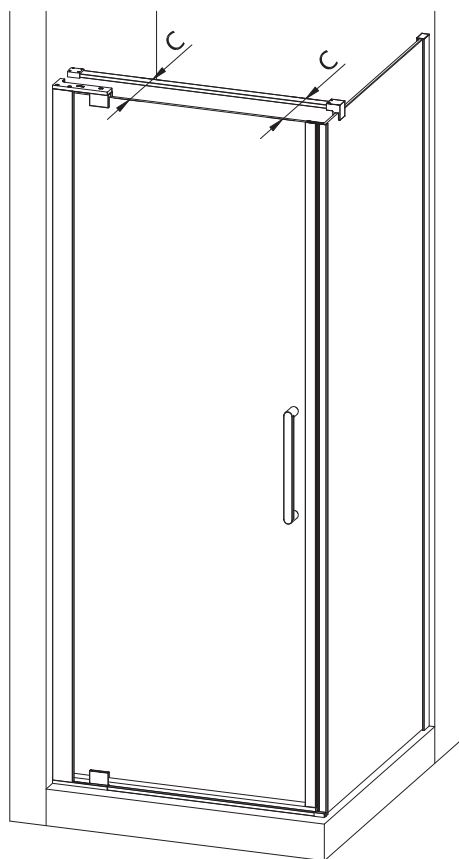

Step B10

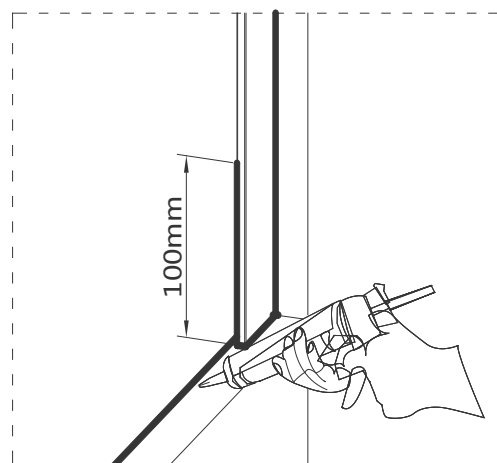
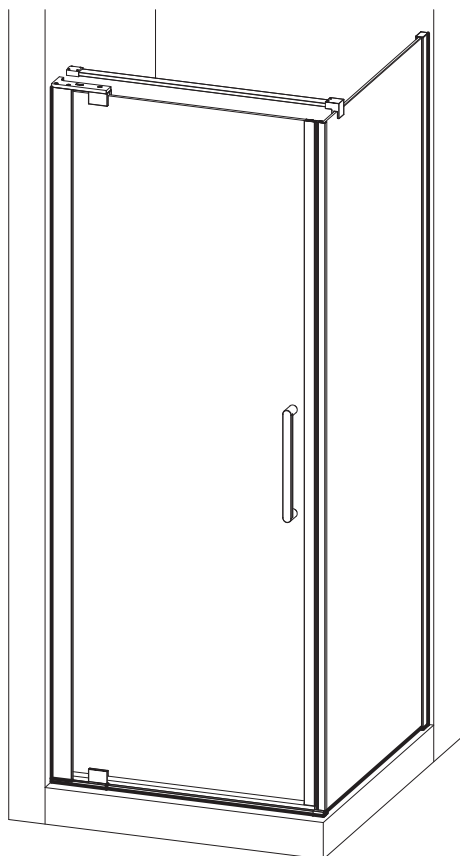

crosswater[®]
SHOWERING

For any further information please contact Crosswater
Phone number, 0345 873 8840

Website, www.crosswater.co.uk

Email address, sales@crosswater.co.uk

The manufacturer reserves the right to make technical
modifications without prior notice.