

SR0R91400

INSTALLATION INSTRUCTION FOR HIGH FLOW WASTE - STHFW6190

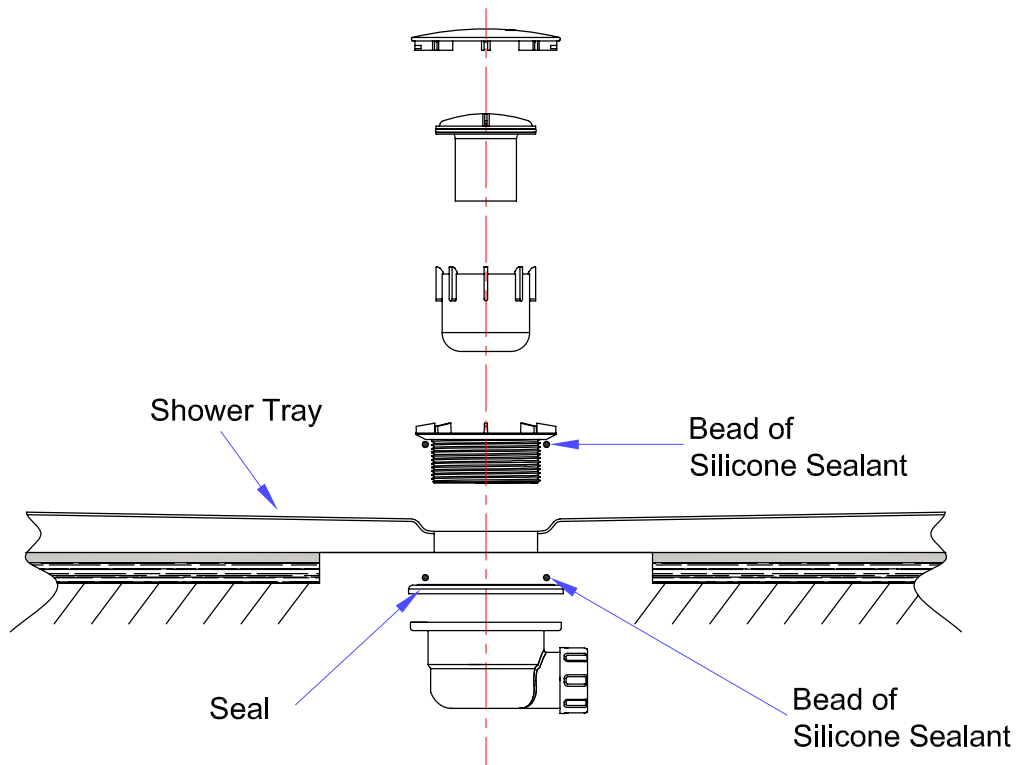

Maintenance:

- Remove the waste cover.
- Remove the inner filter.
- Clean with hot soapy water.
- Re-assemble in reverse order.

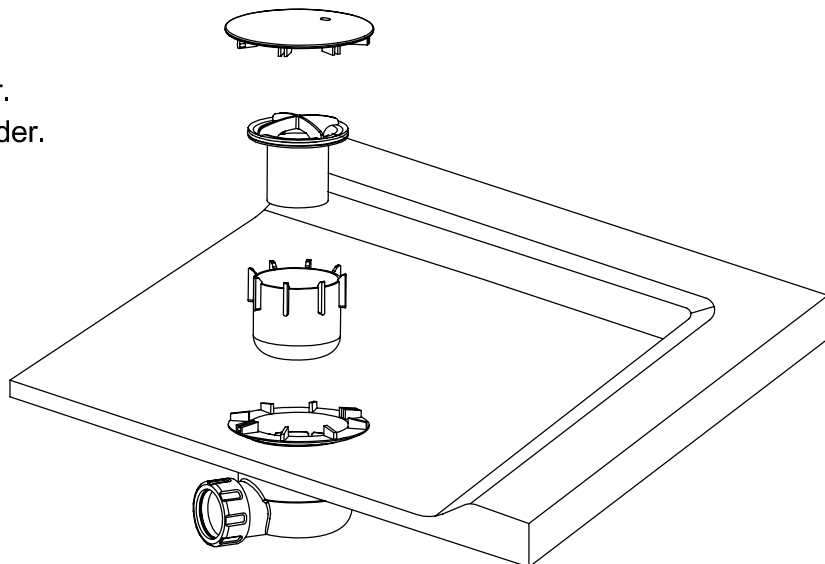

simpsons 

For any further information please contact Crosswater on 01483 303711
Or visit our web-site at www.simpsons-enclosures.co.uk
The manufacturer reserves the right to make technical modifications
without prior notification.

crosswater 

For any further information please contact Crosswater on 01322 628270
Or visit our web-site at www.crosswater.co.uk
The manufacturer reserves the right to make technical modifications
without prior notification.